



CIVIL ENGINEERING STUDIES
Illinois Center for Transportation Series No. 08-024
UIIU-ENG-2008-2012
ISSN: 0197-9191

EVALUATION OF VIDEO DETECTION SYSTEMS VOLUME 1: EFFECTS OF CONFIGURATION CHANGES IN THE PERFORMANCE OF VIDEO DETECTION SYSTEMS

Prepared By

**Juan C. Medina
Rahim F. Benekohal
Madhav Chitturi**

University of Illinois at Urbana-Champaign

Research Report ICT-08-024

A report of the findings of
ICT-R43
Video Detection Evaluation at Traffic Operations Laboratory

Illinois Center for Transportation

September 2008

Technical Report Documentation Page

1. Report No. FHWA-ICT-08-024	2. Government Accession No.	3. Recipient's Catalog No.	
4. Title and Subtitle Evaluation of Video Detection Systems, Volume 1 - Effects of Configuration Changes in the Performance of Video Detection Systems		5. Report Date October 2008	
7. Author(s) Juan C. Medina, Rahim F. Benekohal, Madhav Chitturi		6. Performing Organization Code	
9. Performing Organization Name and Address Department of Civil and Environmental Engineering University of Illinois at Urbana-Champaign 205 N. Mathews Ave Urbana, IL 61801		8. Performing Organization Report No. ICT-08-024 UIIU-ENG-2008-2012	
12. Sponsoring Agency Name and Address Illinois Department of Transportation Bureau of Material and Physical Research 126 East Ash Street Springfield, IL 62704		10. Work Unit (TRIS)	
15. Supplementary Notes		11. Contract or Grant No. ICT- R-43	
16. Abstract The effects of modifying the configuration of three video detection (VD) systems (Iteris, Autoscope, and Peek) are evaluated in daytime and nighttime conditions. Four types of errors were used: false, missed, stuck-on, and dropped calls. The three VD systems were installed side-by-side at an intersection in Rantoul, IL. The configurations were modified by the vendors to improve their performance. The modifications to Peek VD configuration effectively reduced dropped calls at the stop bar zones; however, that was at the expense of increasing false calls during daytime and missed and false calls during night time. Similarly, in the advance zones, in both daytime and nighttime, there was a clear tradeoff between decreasing missed calls and increasing false calls. The modifications to Autoscope VD configuration did not provide a clear improvement at the stop bar zones during daytime; however, during nighttime, false calls increased and missed calls were eliminated. In the advance zones, the Autoscope changes significantly reduced missed calls in both day and night, reduced false calls in daytime, but increased in false calls during nighttime. The modifications to Iteris VD configuration were slight and overall effects of the changes were relatively small. This resulted in a tradeoff between false and missed calls. The results for three systems indicate that there are tradeoffs when the goal is to improve the overall performance of VD systems. Thus, after making modifications to the configuration of VD systems, the effects of these changes should be monitored not only for improvements on the previously detected errors, but also for potential new errors of a different type.		13. Type of Report and Period Covered	
17. Key Words Video detection system, vehicle detection at intersections, VD detection zone, Iteris, Peek, Autoscope, stop bar detection, advance detection, video technology, false, missed, stuck-on call, dropped call		18. Distribution Statement No restrictions. This document is available to the public through the National Technical Information Service, Springfield, Virginia 22161.	
19. Security Classif. (of this report) Unclassified	20. Security Classif. (of this page) Unclassified	21. No. of Pages	22. Price

ACKNOWLEDGEMENT

This publication is based on the results of ICT-43, Evaluation of Video Detection Systems. ICT-R43 was conducted in cooperation with the Illinois Center for Transportation; the Illinois Department of Transportation; and the U.S. Department of Transportation, Federal Highway Administration. Members of the Technical Review Panel are the following: Yogesh Gautam, IDOT (Chair), James Schoenherr, IDOT, and Aaron Weatherholt, IDOT.

DISCLAIMER

The contents of this report reflect the view of the authors, who are responsible for the facts and the accuracy of the data presented herein. The contents do not necessarily reflect the official views or policies of the Illinois Center for Transportation, the Illinois Department of Transportation, or the Federal Highway Administration. This report does not constitute a standard, specification, or regulation.

Trademark or manufacturers' names appear in this report only because they are considered essential to the object of this document and do not constitute an endorsement of a product by the Federal Highway Administration, the Illinois Department of Transportation, or the Illinois Center for Transportation.

EXECUTIVE SUMMARY

Three video detection systems (Iteris, Autoscope, and Peek) were installed side-by-side at an intersection in Rantoul, IL for field evaluation. The effects of changing the configuration of the detection zones and systems settings on the performance of the systems are presented for daytime and nighttime conditions. The performance was analyzed based on four types of measures: false, missed, stuck-on, and dropped calls. All errors were first identified using a computer algorithm (potential errors) and later verified using videos from the intersection. The configurations of the detection systems were modified by the vendors to improve their performance. The modifications varied from slight changes in detection zones to complete reconfiguration of the zones. Results of the performance before and after the configuration changes for stop bar and advance detection zones are presented. This study found that the modifications could improve an intended Measure of Performance (MoP), but at the expense of worsening another MoP. In general, dropped calls and missed calls decreased at stop bar locations during the nighttime, but false calls during both daytime and nighttime increased. Also, changes at advance zones decreased missed calls but increased false calls. Thus, one should be cautious when modifying the detection zone configuration to minimize the negative effects in the overall VD performance. Details on the installation, data processing, and the computer algorithms are also provided.

TABLE OF CONTENTS

ACKNOWLEDGEMENT	i
DISCLAIMER	i
EXECUTIVE SUMMARY	ii
TABLE OF CONTENTS.....	iii
Chapter 1 INTRODUCTION	1
Chapter 2 LITERATURE REVIEW	2
Chapter 3 TEST SETUP AND DATA COLLECTION	3
3.1 Test Setup.....	3
3.2 Data Collection.....	4
Chapter 4 PERFORMANCE MEASURES & DATA REDUCTION	10
4.1 Preliminary Identification of Performance Measures	10
4.2 Algorithm for Preliminary Identification	10
4.2.1 False Call Logic	10
4.2.2 Missed Call Logic	11
4.2.3 Stuck-on Call Logic	12
4.2.4 Dropped Call Logic.....	12
4.2.5 Calibration of the Algorithm Parameters.....	13
4.2.6 Validation of Algorithm Parameters.....	18
4.3 Further Enhanced Analyses.....	19
4.3.1 Shadows/Turning Vehicles Causing False Calls	19
4.3.2 Flickering Calls.....	21
4.3.3 Vehicles Changing Lanes	22
4.4 Manual Verification	23
4.5 Summary of Performance Measures & Data Reduction	23
Chapter 5 RESULTS	24
5.1 Effect of Configuration Changes in Peek.....	25
5.1.1 Configuration Changes	25
5.1.2 Daytime Data	26
5.1.3 Nighttime Data.....	28
5.1.4 Operational Effects of Dual Left Turn Lanes in False Calls	30
5.2 Effect of Configuration Changes in Autoscope	31
5.2.1 Configuration Changes	31
5.2.2 Daytime Data	32
5.2.3 Nighttime Data.....	34
5.2.4 Operational Effects of Dual Left Turn Lanes in False Calls	36
5.3 Effect of Configuration Changes in Iteris	37
5.3.1 Configuration Changes	37
5.3.2 Daytime Data	37
5.3.3 Nighttime Data.....	39
5.3.4 Operational Effects of Dual Left Turn Lanes in False Calls	41
Chapter 6 FINDINGS AND CONCLUSIONS	42
REFERENCES	44
APPENDIX A - Calibration of Algorithm Parameters for Initial Setup	45
APPENDIX B - Daily Variation of Video Detection Performance.....	50

CHAPTER 1 INTRODUCTION

Video Detection (VD) systems are increasingly being deployed instead of inductive loops at signalized intersections. Unlike loop detectors that are placed on the road at a fixed location, VD systems use detection zones that are drawn over an image of the road, thus they can be easily relocated to accommodate changes in road conditions (such as lane closures and resurfacing). In addition, VD systems may also be used for counting traffic volumes and providing other data collection capabilities.

Although VD systems have been commercialized for over a decade, there has not been a comprehensive side-by-side evaluation of VD systems from different manufacturers. Some of the previous studies evaluated the VD systems one at a time for a limited range of test scenarios. These past studies have found that the VD system performance is adversely affected by inclement weather conditions, shadows, occlusion, and day-to-night transition, among other factors. In addition, manufacturers have recently claimed major improvements in the VD systems, including superior detection capabilities and improved performance.

This study is aimed to overcome limitations from previous studies and to provide performance results from more recent system versions. Specifically, the detection performance of three widely used VD systems (Iteris, Peek, and Autoscope) was evaluated side-by-side at a signalized intersection. It was very important to evaluate the VD systems when they are performing the “best”, so the manufacturers/distributors were asked to set up their detection configurations to provide the “best” performance. After initial installation, they were given some feedback by the research team and an opportunity to modify their configurations.

The detection zone configuration changes from the first setup by the manufacturers/distributors, and their effects on the VD system performance under normal weather conditions in daytime and in nighttime are documented on this report. Details on the test installation are also provided, as well as the procedures used to collect and analyze the data and evaluate the performance of the VD systems in a fair and balanced manner.

Results of performance evaluations under a wide range of weather and illumination conditions will be presented in separate reports to be published as a part of this study.

CHAPTER 2 LITERATURE REVIEW

Previous research has assessed VD performance under various conditions, such as daytime or nighttime using different approaches. An evaluation of the Vantage Video Traffic Detection System (VTDS) at three intersections was presented by MacCarley (1998). Performance was evaluated under twelve conditions, including combinations of weather, time of day, traffic volume, and electromagnetic interference. Results were based on 15-minute datasets and showed good performance under ideal lighting and light traffic conditions. Performance degradation due to shadows and low lighting conditions, among other factors, was also found. Overall, video detection systems were considered not reliable for general signal actuation.

Later in 2001, Minnesota DOT and SRF Consulting Group (2001) also evaluated the performance of VD systems at intersections. In this case, Peek Video Trak 900, Autoscope 2004, EVA 2000, and TrafficCam systems were installed at different mounting locations and heights. Similar to the MacCarley study, factors such as shadows (both stationary and moving) and wind were also found to affect VD performance. Also in 2001, Grenard, Bullock, and Tarko (2001) evaluated the performance of Econolite, Autoscope, and Peek VideoTrak-905 at a signalized intersection. Results from overcast, night rain, and partly sunny conditions from three days were presented. It was concluded that nighttime detection was a concern, and VD systems should not be used for dilemma zone protection.

More recently, in 2006 and 2007, a study by Rhodes et al. (2006, 2007) that followed the 2001 study by Grenard, Bullock, and Tarko (2001), indicated significantly more false and missed detections using VD systems than inductive loop detectors. The study installed three systems next to each other: Autoscope (version 8.10), Peek UniTrak (version 2), and Iteris Vantage (Camera CAM-RZ3). Results from two full days of data were analyzed, finding that all the three VD systems had moderate to high degree of missed and false calls and none was superior to the others. An additional publication by Rhodes et al. (2007) evaluated the stochastic variation of activation/deactivation times between day and night condition using data from one day, finding earlier detections at night due to headlight reflection in the pavement.

Thus, data used in previous studies seem rather limited, being very difficult to control or to account for specific factors that affect VD performance. In studies of McCarley and Grenard, a real-time side-by-side comparison of the VD systems was not performed. In Rhodes and MnDOT studies, a real-time side-by-side comparison of the VD systems was performed, but limited datasets were used (2 days in Rhodes and 1 day in McCarley). It is noted that setups using side-by-side comparisons can clearly provide an advantage over other installations as the VD systems are processing the same images using their own camera.

This study has been designed in the light of past research and to give answers to the limitations just described. Some of the key features of this study are: 1) a true side-by-side installation to obtain the field data and compare three of the leading VD systems in the market; 2) datasets from multiple days, obtained through a multistage analysis procedure that includes automation in the computation of the performance measures (PMs), and final visual inspection of every PM using video recorded images of the selected site; and 3) very specific conditions chosen for the analysis, controlling for individual factors affecting VD performance and quantifying their effect on the different PMs.

CHAPTER 3 TEST SETUP AND DATA COLLECTION

3.1 TEST SETUP

The study site is the eastbound approach of the intersection of Veteran's Parkway (U.S. Route 45) and S. Century Blvd. in Rantoul, IL. As shown in Figure 3-1, the study approach has two left-turn lanes and a shared right-thru lane. The speed limit on this approach drops from 45mph to 40mph and to 35 mph near the intersection. Apart from the Illinois Department of Transportation (IDOT) cabinet that houses the controller for the intersection, a separate cabinet was used to house the VD equipment and the data collection equipment for this study. The VD systems being evaluated do not affect the signal performance in any way.

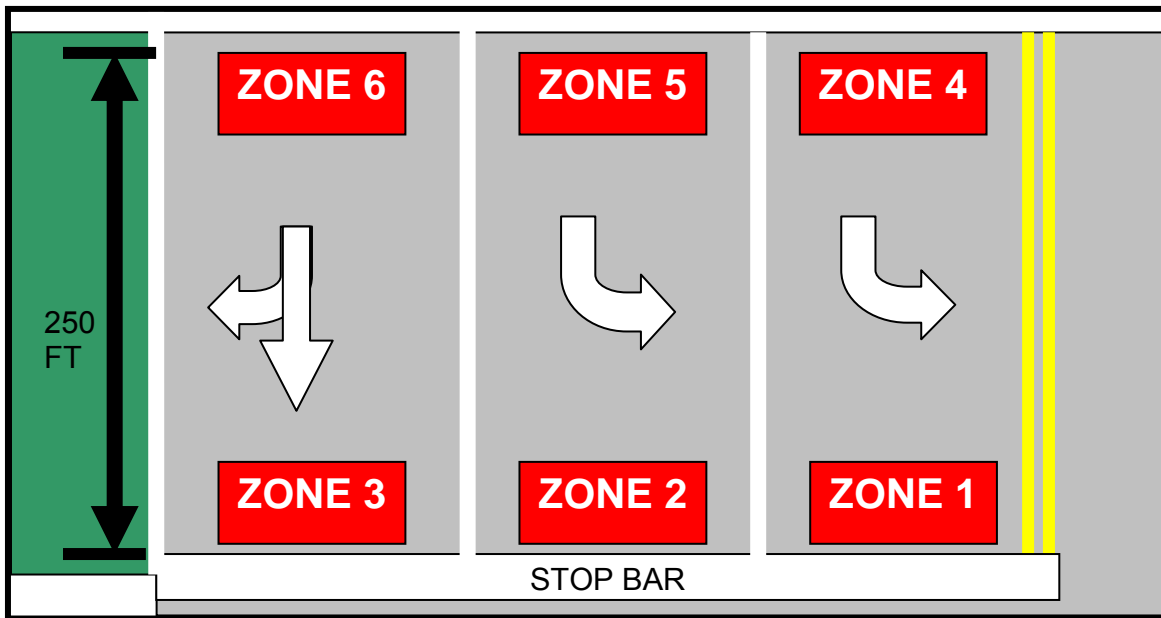

Figure 3-1. Schematic diagram of the study approach.

Cameras from the three manufacturers were installed at a height of approximately 40 ft on the luminaire arm located on the eastbound approach (shown in Figure 3-2). This intersection is fully actuated and uses the Iteris video detection system. Of the four cameras shown in Figure 3-2, the right three are the cameras from the three manufacturers being evaluated in this study. The leftmost camera is part of the Iteris VD system that is being used for the intersection operation. Each of the other approaches has a similar Iteris camera.

In addition to the VD systems, inductive loops (each 6ft × 6ft) were installed at the stop bar and advance locations on all the three lanes. The purpose of inductive loops is to serve as the pointer to potential detection errors, and visual inspection is the actual base against which the performance of the VD systems is compared. The VD system manufacturers were requested to set up their configurations such that vehicles can be detected at the stop bar and at advance locations as well. The advance locations are about 250 ft upstream from the stop bar locations.

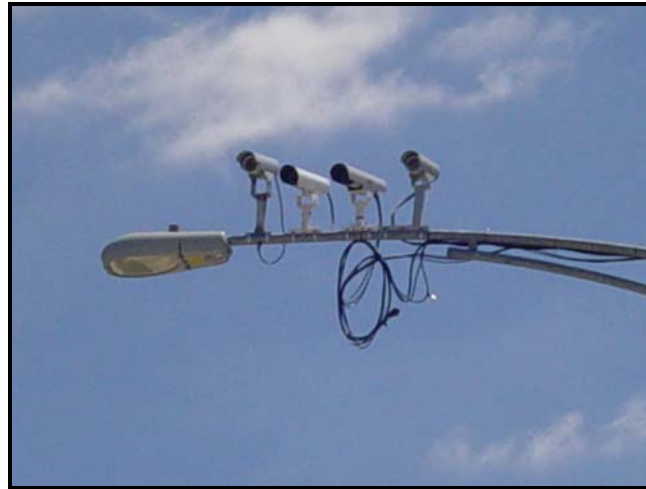

Figure 3-2. Cameras on the luminaire arm.

3.2 DATA COLLECTION

As mentioned earlier, one of the limitations of several previous studies is that their conclusions are based on small datasets. In order to overcome this limitation, it was important to collect large sets of data and to be able analyze them in a semi-automated way using computer algorithms. However, it is noted that a computer algorithm may not be able to address all possible issues, thus in addition to the timestamps (times at which each of the VD zones or inductive loops were activated or deactivated), video images were also collected in this study.

The idea behind collecting timestamps was that their analyses could be automated using computer programs. The recorded video images are used to calibrate and validate the algorithm, and to provide a base for verification to the preliminary results given by the computer algorithm. The video images also serve as a ground truth to check if the loop detectors are working properly. The video data is also required for ascertaining the lighting/weather/traffic condition at the study location.

In the detector rack, the presence of a vehicle is indicated by no voltage on the channels, and the absence of vehicle is indicated by 24V DC. Consequently, a device capable of sensing voltage on multiple channels (32 channels) was used to monitor the presence or absence of the vehicles (OPTO 22 SNAP I/O). SNAP I/O device is a programmable input/output device that can monitor signals on incoming channels and take appropriate control actions using output channels.

In this study, the I/O device was instrumented to monitor the four detection states (one from the inductive loop and three from the VD systems) at each of the six detection locations (three at the stop bar and three at the advance locations), resulting in 24 channels for monitoring. The I/O device verifies the state of these 24 detectors once every 50 milliseconds resulting in 20 checks per second. The I/O device has been programmed to record the timestamps for each of the six detection locations separately. At each detection location, whenever the detection state of any of the four detectors (three VD and 1 loop) changes, the time and the state of all the four detectors is recorded. Every hour the timestamp data is uploaded to the computer located in the data collection cabinet. Figure 3-3 depicts the process to record the timestamps.

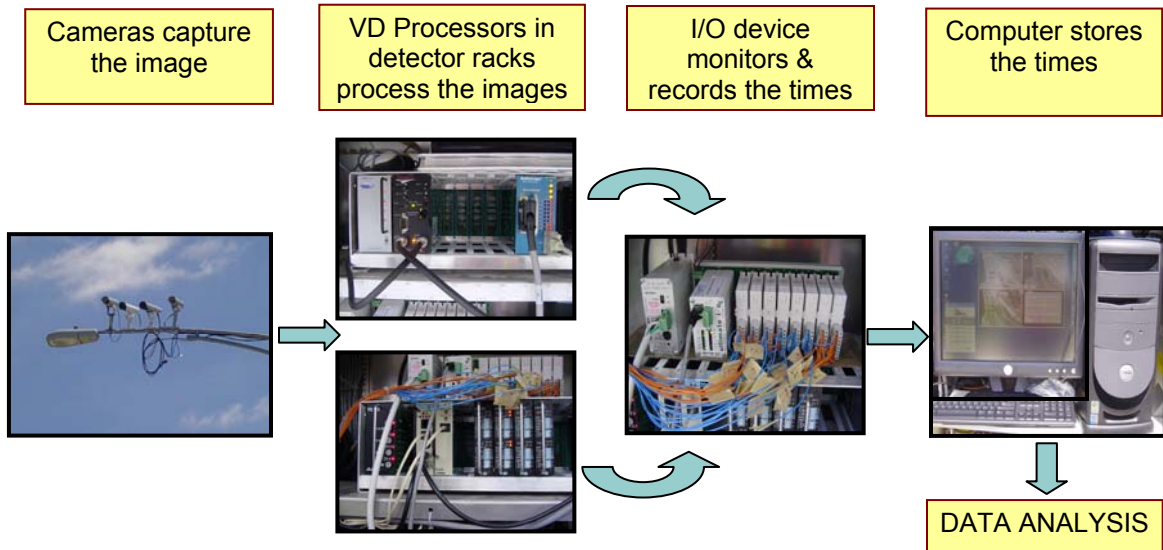

Figure 3-3. Setup for recording the timestamps.

Figure 3-4 shows a sample timestamp dataset recorded by the I/O device. The first column is the row number or observation number, followed by the detection zone number and the time at which the timestamp was generated. The next four columns are the detection states of loop, Peek, Iteris, and Autoscope, in that order. A value of “1” indicates the presence of a vehicle and “0” indicates absence of any vehicle.

Row	Zone	Time	Loop	Peek	Iteris	Autoscope
[12]:	1	14:35:26	0	1	0	1
[13]:	1	14:35:26	0	0	0	1
[14]:	1	14:35:27	0	0	0	0
[15]:	1	14:37:12	0	0	1	0
[16]:	1	14:37:12	0	1	0	0
[17]:	1	14:37:13	0	0	0	0
[18]:	1	14:37:13	0	0	1	0
[19]:	1	14:37:14	0	0	1	1
[20]:	1	14:37:14	0	1	1	1
[21]:	1	14:37:14	1	1	1	1
[22]:	1	14:37:15	0	1	1	1
[23]:	1	14:37:15	0	1	0	1
[24]:	1	14:37:15	0	0	0	1
[25]:	1	14:37:15	0	0	0	0
[26]:	1	14:37:34	0	0	0	1
[27]:	1	14:37:34	0	0	1	1
[28]:	1	14:37:35	0	1	1	1
[29]:	1	14:37:36	1	1	1	1
[30]:	1	14:37:41	0	1	1	1
[31]:	1	14:37:42	0	1	0	1
[32]:	1	14:37:42	0	0	0	1
[33]:	1	14:37:43	0	0	0	0

Figure 3-4. Sample timestamp data recorded by the I/O device.

In addition to the timestamp data, video data was recorded on the computer in the data collection cabinet. Figure 3-5 depicts the process to record the video images. The processed images from the three VD cards were fed as inputs to a quad processor. When given four images as input, the quad processor has the capability to produce a single image with all the four images in it (such an image is called a quad image). Figure 3-6, shows a sample of the recorded image. The images of Autoscope, Peek, and Iteris are labeled A, P, and I respectively. When the VD zones are activated, they change the color of the arrows/boxes or highlight the corners. However, there is no visual indication of the status of the loops detectors. Therefore, a real-time graphical depiction of the detector states was generated, using the I/O device to indicate the status of the loops and the three VD systems at the six detection locations. The graph shows the status of the detections in the last two minutes, and it is updated every 125 milliseconds for the advance locations and every 250 milliseconds for the stop bar locations. This image was fed as the fourth input to the quad processor. The video recording was scheduled to cover the sunrise, sunset, day, and night conditions.

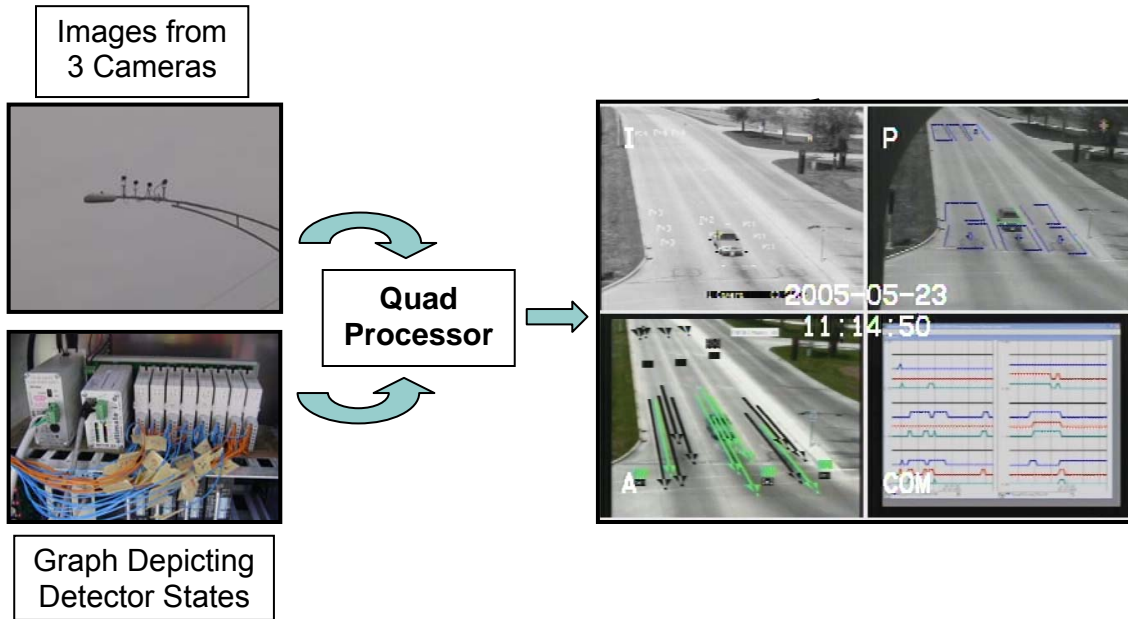

Figure 3-5. Data flow to process images.

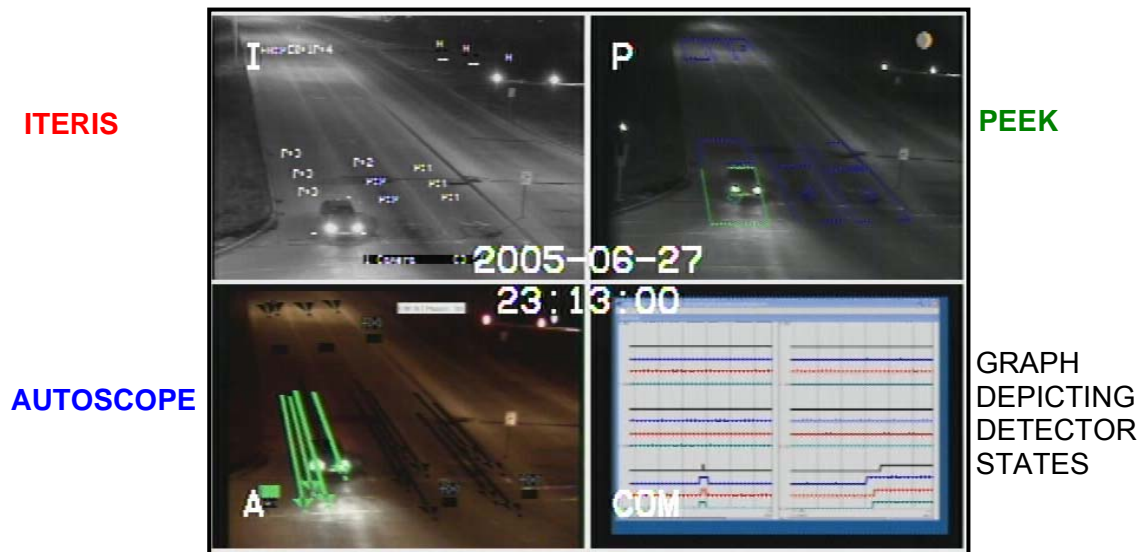

Figure 3-6. Sample recorded image.

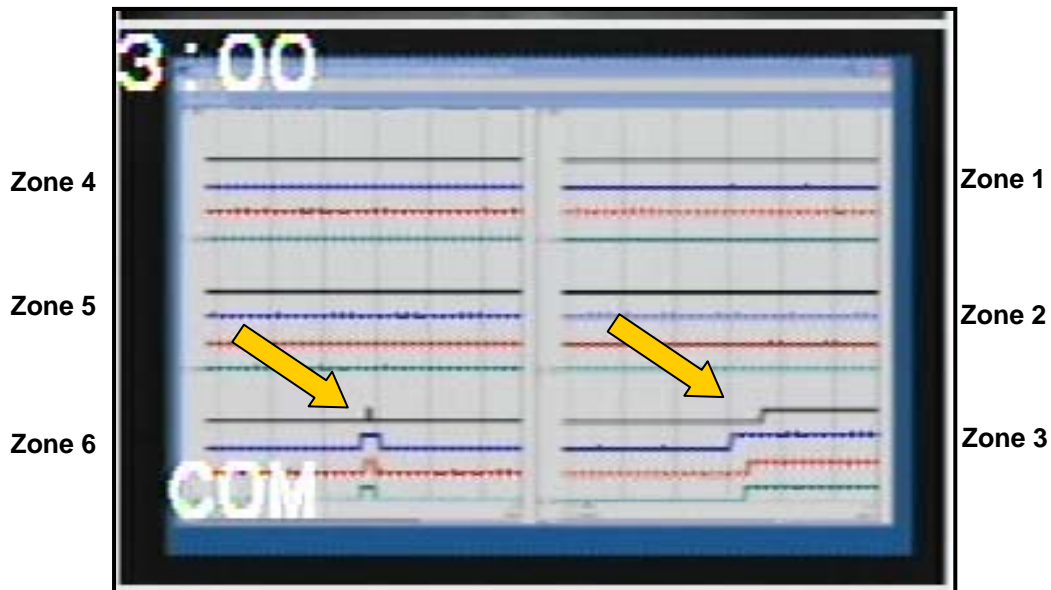

Figure 3-7. Real-time graph depicting the detector states.

Figure 3-7 shows a detailed image of the real-time graph that appears in the lower right quadrant in Figure 3-6. It should be noted that there are six sub-graphs corresponding to the six detection locations (three at stop bar and three at the advance locations). Each sub-graph has 4 lines: black, blue, red, and green corresponding to the status of loop, Autoscope, Iteris, and Peek in that order. When the line corresponding to a system is “low” it indicates that the system did not detect any vehicle presence and when it is “high” the system detected the presence of a vehicle. Figure 3-6 shows a vehicle waiting at the stop bar in the right-thru lane (Zone 3). Figure 3-7 shows that all the three VD systems and the loop detected the vehicle at the stop bar location (Zone 3). Also all the VD systems and the loop detected the vehicle at the advance location (Zone 6) on the right-thru lane as well. There was no vehicle present in the previous two minutes at any of the other locations, thus the lines of all the three VD systems and the loop at these locations are “low”.

All the three manufacturers installed their cameras and configured the VD systems, and the data collection was started on August 1st 2005 (Setup 1). After collecting and analyzing the data for about 7 weeks, the manufacturers were provided performance data and videos of their systems and were given an opportunity to make any modifications and improve the performance of their systems.

The manufacturers made some modifications of the VD system configurations. The research team sent the manufacturers about two hours of video images so they could see how their system is working and if they wanted to make the final refinements. Some took that opportunity and made some refinement to their configurations. Then, Setup 2 data collection started on November 1, 2005. The VD configurations in Setup 1 and Setup 2 are shown in Figure 3-8 and Figure 3-9 respectively.

Comparing the VD configurations in Setup 1 to Setup 2, the changes made by the manufacturers/distributors of Peek and Autoscope systems can be considered major, while the changes made by Iteris can be considered minor (modifying slightly the size of the stop bar zones).



Figure 3-8. VD configuration in initial setup (Setup 1).



Figure 3-9. VD configuration in manufacturers' best setup (Setup 2).

The data from Setup 1 is only used to evaluate the effects of changing the detection zones configuration. The comparisons and results of the VD performances under a wide array of weather and illumination conditions, presented in separate reports from this study, are based on Setup 2. Recall that this report includes the comparison of the performances of the VD systems in Setup 1 and Setup 2 during daytime and nighttime under normal weather conditions.

CHAPTER 4 PERFORMANCE MEASURES & DATA REDUCTION

To quantify the performance of the VD systems, the following four performance measures (PMs), or errors, are studied:

- False call - VD systems detect a vehicle, but actually no vehicle is there.
- Missed call - VD system does not detect a vehicle that actually is there.
- Stuck-on call - VD system continues to detect a vehicle, but the vehicle is no longer there.
- Dropped call - VD system correctly detects the vehicle's presence, but later on indicates that it is not there anymore while the vehicle is there.

This chapter describes the PMs and the data reduction procedures. The data reduction is accomplished in two stages: the first stage comprised of analysis of the timestamps by the algorithm to identify the potential errors; in the second stage a visual (manual) verification of the potential errors is performed. The algorithms for the automated analysis, their calibration, and validation are also discussed in the following sections.

4.1 PRELIMINARY IDENTIFICATION OF PERFORMANCE MEASURES

A computer program was written in SAS to automatically analyze the timestamp datasets and quantify the PMs. In this preliminary stage, broad definitions for the PMs (as shown in Table 4.1) are used.

Error	GROUND TRUTH (Verified Loop Calls)	VD Indicates	Explanation
False Call	No vehicle	Vehicle is present	Places a call for no vehicles
Missed Call	Vehicle is present	No vehicle	Vehicle is present but no call is placed
Stuck-on Call	Vehicle was present	Vehicle is present	Vehicle left, but call is maintained
Dropped Call	Vehicle is present	Vehicle was present	Vehicle is still present, but call is dropped

Table 4.1. Definitions of the performance measures.

In the following sub-sections, the logic implemented in the SAS program for preliminary quantification of the PMs is explained.

4.2 ALGORITHM FOR PRELIMINARY IDENTIFICATION

4.2.1 False Call Logic

For every call by a VD system, if there is no corresponding call from the loop detector, it is considered a potential false call. The algorithm (illustrated in

Figure 4-1) verifies if there is a loop call placed in a time window that starts “X” seconds before the beginning of the VD call and ends “Y” seconds after the VD call is dropped. If there is no loop call in this time window, it is considered that the VD system had a potential false call.

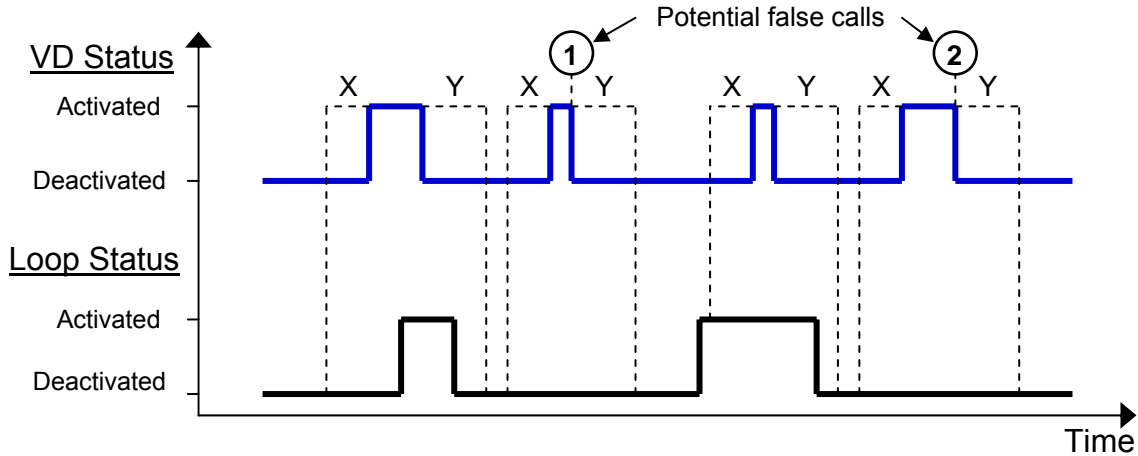

Figure 4-1. False call logic.

It is necessary to use the time windows of “X” and “Y” seconds because the VD zones and loops are not exactly located at the same place or are of the same size. In addition, the primary interest is if the VD systems detect the vehicle presence or not.

It should be noted that the implicit assumption in this logic is that the loops accurately detect vehicles and thus are adequate for identifying the potential errors. As stated before, this is only a preliminary identification of the error. That is why these errors are considered potential errors at this stage. In the later stage, further enhanced analyses and visual inspections (described in the following sections) are performed to verify if the initial determination is accurate.

4.2.2 Missed Call Logic

For every valid loop call, if there is no corresponding VD call, it is considered a potential missed call. As shown in Figure 4-2, the algorithm checks if there is a VD call in a window that starts “X” seconds before the start of loop call and ends “Y” seconds after the end of the loop call. If no VD call is in this window, it is counted as a potential missed call. Note that the X or Y values for false, missed, stuck-on, and dropped calls are not necessarily the same.

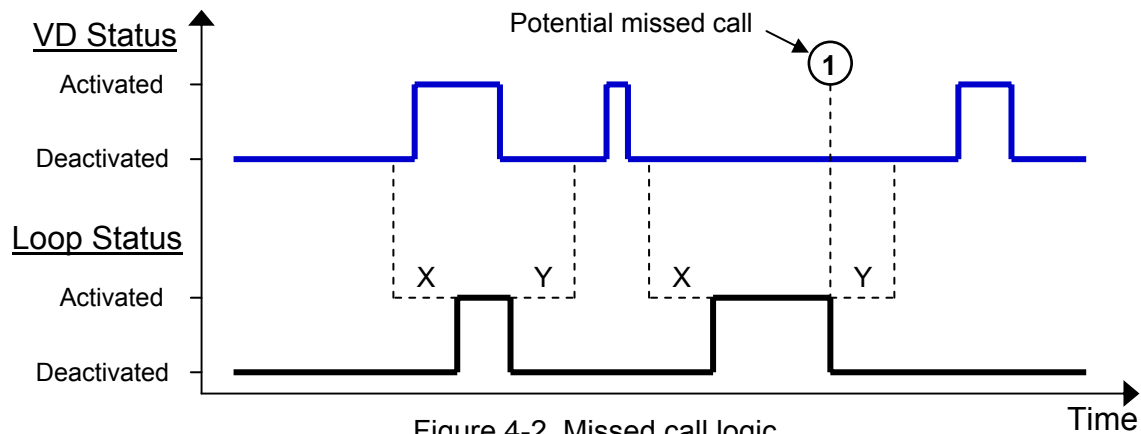

Figure 4-2. Missed call logic.

4.2.3 Stuck-on Call Logic

For efficient operation of the intersection, the calls placed to the controller should be dropped once the vehicle departs. However, it was observed that sometimes the VD systems do not drop the calls after the departure of the vehicles. “Stuck-on calls” are used to quantify this aspect of the performance. As shown in

Figure 4-3, if the VD call continues to be active more than “X” seconds after the end of the loop call, it is counted as a potential stuck-on call.

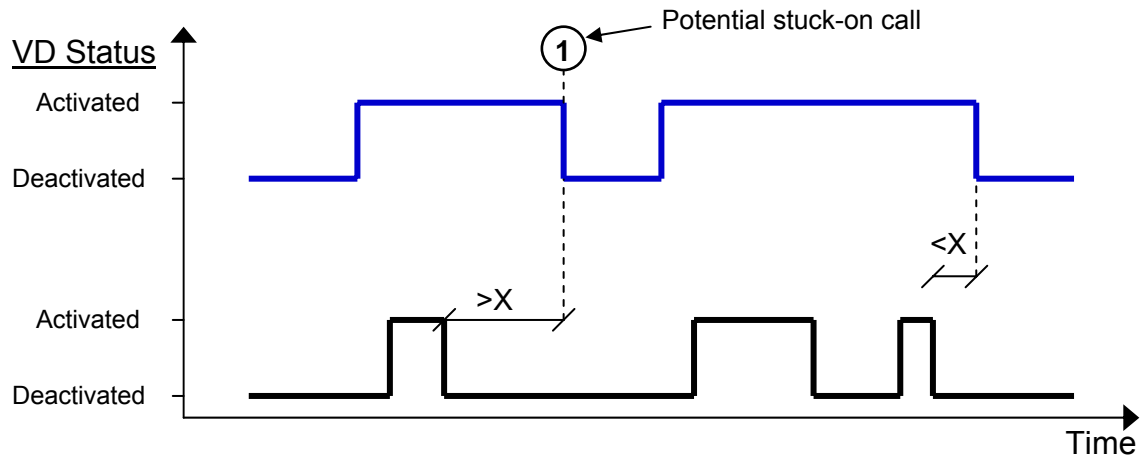

Figure 4-3. Stuck-on call logic.

4.2.4 Dropped Call Logic

Under some conditions, it was observed that the VD systems prematurely dropped the call, even though the vehicle was still present in the detection area. These occurred especially at night when the headlights of the vehicles were no longer falling on the VD zones. If the detection in the traffic controller is in non-locking mode, dropped calls may cause drivers to be undetected and that may lead to driver frustration. As illustrated in Figure 4-4, if the VD call is terminated more than “X” seconds before the end of loop call, it is considered as a potential dropped call.

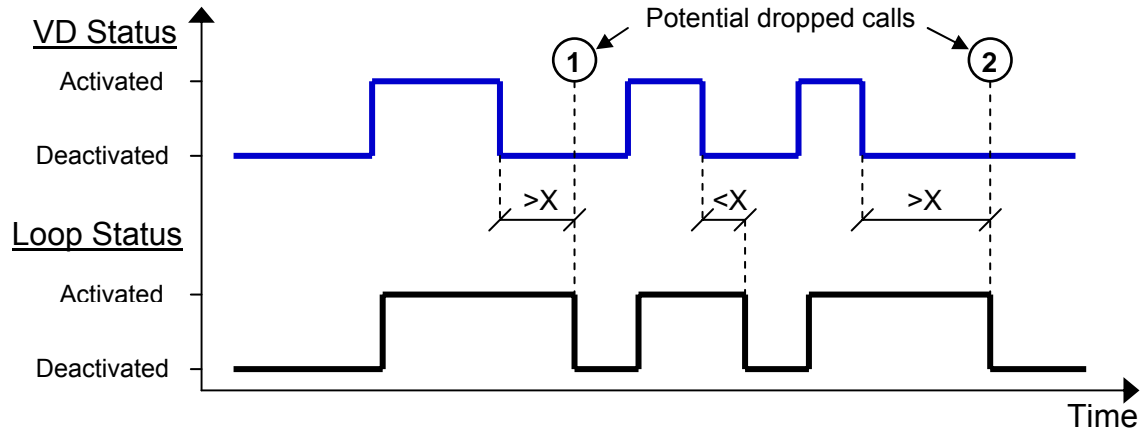

Figure 4-4. Dropped call logic.

4.2.5 Calibration of the Algorithm Parameters

As shown in Figure 4-5, the detection zones of each of the VD systems have different shapes and sizes. Also, the VD zones are different in shape and size than the loop detectors. Consequently, the algorithms for computing the four performance measures utilize different time windows for different VD systems, as these windows will depend on the location and size of the detection zones. Therefore, these parameters have to be calibrated for the given configuration of VD zones. The procedure used for calibration is presented in this section.



Figure 4-5. Configuration of VD zones in initial setup.

Based on the experience gained by watching the videos, a set of values were used as the preliminary values for X and Y, as shown in Table 4.2. From Figure 4-5, it can be

observed that the advance zones of Peek are significantly bigger than the advance zones of Autoscope and Iteris. Thus, a different set of values had to be used for determining potential false and missed calls in Peek's advance zones.

Performance Measures	Variable X	Variable Y
Dropped Call	4 sec	n/a
Missed Call	2 sec	1 sec (3 sec*)
False Call	3 sec (5 sec*)	3 sec
Stuck-on Call	10 sec	n/a

*: Values for Peek's advance zones

Table 4.2. Preliminary Values for the Algorithm Parameters for Setup 1.

The expected values for the four performance measures (PMs) were obtained by watching the videos for three datasets. Each of the datasets was one hour long. Two of the three datasets were from noon time and one was from night time. None of the datasets had any rain, wind, fog or any such inclement weather condition.

The above mentioned algorithms (with the starting values for the parameters) for computing the PMs were coded in a SAS program. The timestamps corresponding to the three datasets were used as input to the SAS program and the PMs were computed. The computed PMs were compared to the expected PMs, and the values for the parameters were modified such that the PMs computed by the SAS program match the expected PMs.

The values for the algorithm parameters are shown in Table 4.3. For illustration purposes, the calibration results for Zones 1 and 4 from one of the noon datasets are presented in this section. The calibration results for the other zones in this dataset and other datasets are presented in Appendix A.

Performance Measure	Stop Bar Zones		Advance Zones	
	Variable X	Variable Y	Variable X	Variable Y
Dropped Call	5 sec	n/a	5 sec	n/a
Missed Call	2 sec (3 sec*)	1 sec (0 sec*)	1 sec (0 sec*)	2 sec (4 sec*)
False Call	1 sec (0 sec*)	2 sec (3 sec*)	2 sec (4 sec*)	1 sec (0 sec*)
Stuck-on Call	10 sec	n/a	10 sec	n/a

*: Values for Peek's zones

Table 4.3. Algorithm Parameters for Setup 1.

Figure 4-6 shows the expected, computed pre-calibration, and computed post-calibration false calls. Expected false calls refer to the number of false calls the SAS program is expected to return after processing the data. This was obtained by watching the video. Computed pre-calibration false calls refer to the number of false calls computed by the SAS program with the preliminary values for the algorithm parameters. Post-calibration computed false calls are the number of false calls computed by the SAS program using the algorithm parameters given in Table 4.3.

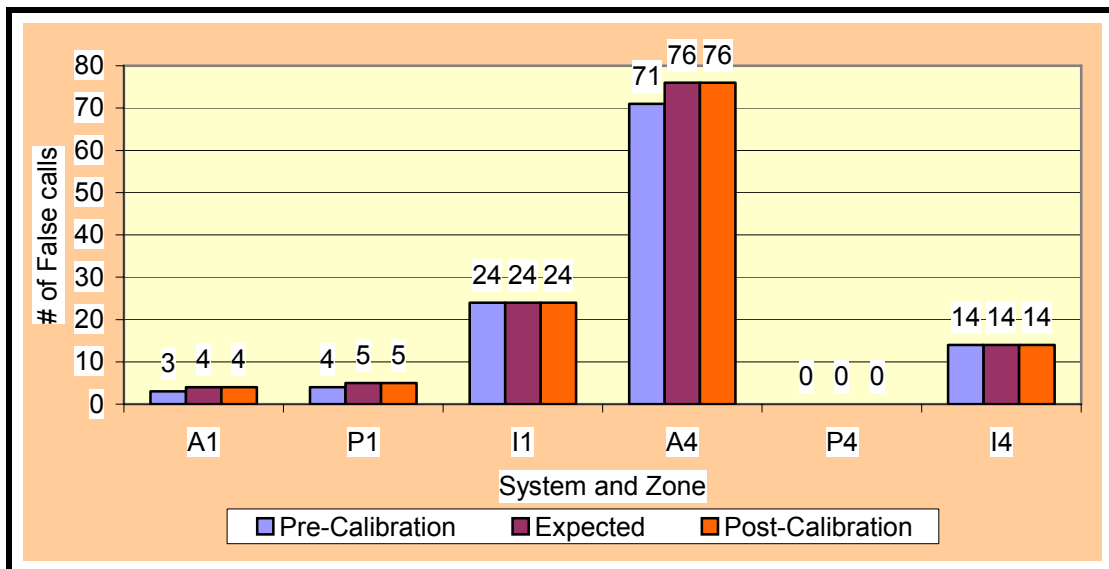

Figure 4-6. Expected and computed false calls from Aug 11 noon data in Zones 1 & 4.

It should be noted that “expected” false calls may not be same as the “total” number of false calls observed in the video. For example, if the shadow of a truck activates the VD

zone in the adjacent lane, it is a false call. But before this “false” call is dropped, if a vehicle arrives in the adjacent lane it would continue the call that began due to the truck shadow. Due to the unique nature of these situations, the SAS program has not been designed to handle them. Therefore, in this case the expected number of false calls is one less than the total number of false calls.

In Figure 4-6, the number of false calls is shown on the y-axis, and the VD system and zone number are shown on the x-axis. For example “A1” refers to Autoscope Zone 1, “P1” refers to Peek Zone 1 and “I1” refers to Iteris Zone 1. The pre-calibration false calls were less than the expected false calls in three cases. However the post-calibration numbers match the expected false calls in all the cases. Similarly the post-calibration numbers match the expected numbers for missed calls and stuck-on calls as shown in Figure 4-7 and Figure 4-8, respectively. Dropped calls did not occur, and in both post-calibration and pre-calibration phases, the computed numbers for dropped calls were zero.

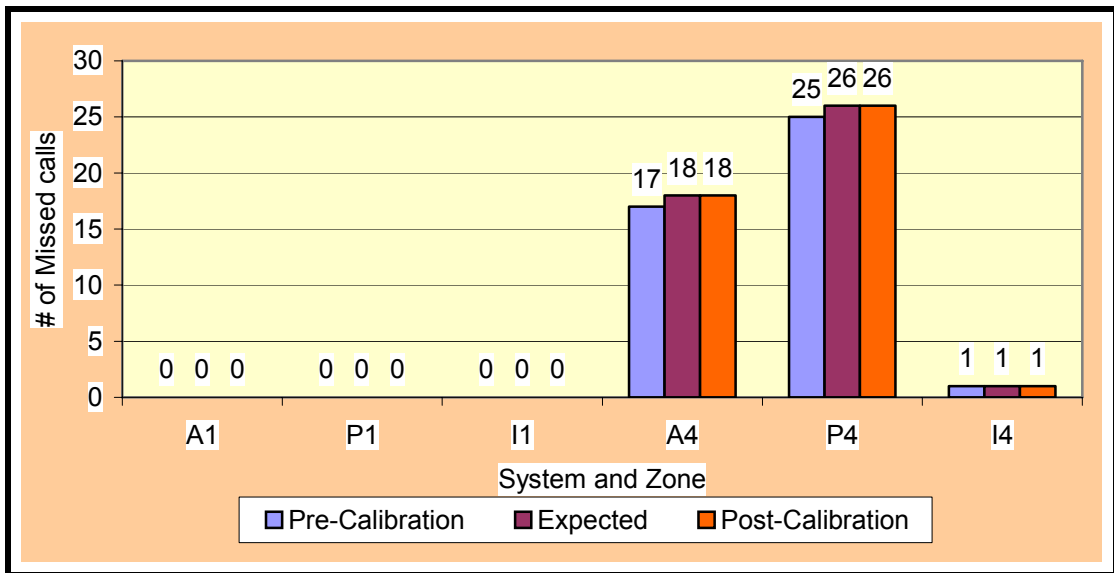

Figure 4-7. Expected and computed missed calls from Aug 11 noon data in Zones 1 & 4.

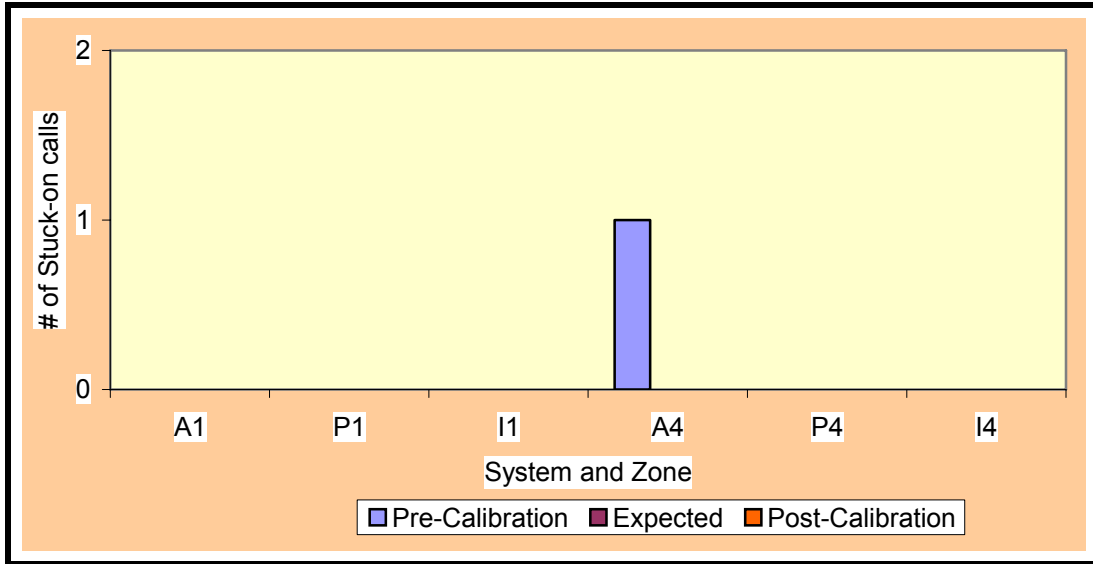

Figure 4-8. Expected and computed stuck-on calls from Aug 11 noon data in Zones 1 & 4.

As mentioned before, the algorithm parameters depend on the VD zone configuration. Consequently this procedure was repeated to calibrate the algorithm for Setup 2 (after the manufacturer/distributor changes to the VD configuration). The values of the parameters for Setup 2 are shown in Table 4.4.

Performance Measure	Stop Bar Zones		Advance Zones	
	Variable X	Variable Y	Variable X	Variable Y
Dropped Call	5 sec	n/a	5 sec	n/a
Missed Call	2 sec (3 sec*)	1 sec (0 sec*)	1 sec (0 sec*)	2 sec (4 sec*)
False Call	1 sec (1 sec*)	2 sec (3 sec*)	3 sec (5 sec*)	1 sec (0 sec*)
Stuck-on Call	10 sec	n/a	10 sec	n/a

*: Values for Peek's zones

Table 4.4. Algorithm Parameters for Setup 2.

4.2.6 Validation of Algorithm Parameters

In the previous section, the calibration procedure, the values of the algorithm parameters after calibration, and the result of calibration have been discussed. In this section, the post-calibration values are validated. Validation was performed using two different datasets than the one used before: one from night time and one from noon time. Datasets were 1 hour long each. The expected values for the four PMs were obtained by watching the videos and these were compared with the computed values.

Table 4.5 and Table 4.6 show the expected PMs and the computed PMs by the SAS program for the noon dataset and the night dataset, respectively. It can be seen that for all the zones, in both the datasets, the expected numbers matched the computed numbers. Thus for this VD zone configuration, the values of the algorithm parameters yield the expected numbers for all the performance measures.

The same procedure was used for validating the algorithm parameters for Setup 2, finding that the computed PMs matched the expected PMs.

ZONE 1								
	False calls		Missed Calls		Stuck-on calls		Dropped calls	
	Computed	Expected	Computed	Expected	Computed	Expected	Computed	Expected
Auto	1	1	0	0	0	0	0	0
Peek	3	3	0	0	0	0	0	0
Iteris	6	6	0	0	0	0	0	0
ZONE 2								
Auto	1	1	0	0	0	0	0	0
Peek	1	1	0	0	0	0	2	2
Iteris	3	3	0	0	0	0	0	0
ZONE 3								
Auto	0	0	0	0	1	1	0	0
Peek	0	0	0	0	0	0	0	0
Iteris	0	0	0	0	0	0	0	0
ZONE 4								
Auto	1	1	29	29	0	0	0	0
Peek	1	1	27	27	0	0	0	0
Iteris	5	5	2	2	0	0	0	0
ZONE 5								
Auto	9	9	4	4	0	0	0	0
Peek	0	0	26	26	0	0	0	0
Iteris	15	15	0	0	0	0	0	0
ZONE 6								
Auto	0	0	0	0	0	0	0	0
Peek	0	0	14	14	0	0	0	0
Iteris	0	0	0	0	0	0	0	0

Table 4.5. Comparison of expected and computed PMs for noon dataset.

ZONE 1								
	False calls		Missed Calls		Stuck-on calls		Dropped calls	
	Computed	Expected	Computed	Expected	Computed	Expected	Computed	Expected
Auto	1	1	0	0	1	1	0	0
Peek	1	1	0	0	0	0	5	5
Iiteris	5	5	0	0	0	0	0	0
ZONE 2								
Auto	30	30	0	0	1	1	0	0
Peek	2	2	0	0	0	0	9	9
Iiteris	2	2	0	0	1	1	0	0
ZONE 3								
Auto	10	10	0	0	0	0	0	0
Peek	0	0	0	0	0	0	12	12
Iiteris	0	0	0	0	0	0	0	0
ZONE 4								
Auto	0	0	13	13	0	0	0	0
Peek	0	0	9	9	0	0	0	0
Iiteris	4	4	0	0	0	0	0	0
ZONE 5								
Auto	37	37	2	2	0	0	0	0
Peek	1	1	7	7	0	0	0	0
Iiteris	19	19	1	1	0	0	0	0
ZONE 6								
Auto	12	12	0	0	0	0	0	0
Peek	0	0	10	10	0	0	0	0
Iiteris	3	3	0	0	0	0	0	0

Table 4.6. Comparison of expected and computed PMs for night dataset.

4.3 FURTHER ENHANCED ANALYSES

As explained above, the data reduction is accomplished in two stages, and the logics used in the first stage identified the potential errors. As a complement to the first stage, additional algorithms were implemented to handle some special cases that the previous logic could not handle. These special situations are discussed in the following sections.

4.3.1 Shadows/Turning Vehicles Causing False Calls

Shadows of vehicles could potentially activate the VD zones on adjacent lanes. As mentioned above, in this location there are two left turn lanes and one shared right-thru lane (Figure 4-9 shows the schematic diagram of the study approach). It should be noted that this is the eastbound approach of the intersection, thus the shadows of vehicles in the right-thru lane fall on the left-turn lanes and the shadows of vehicles in the middle lane fall on the median left-turn lane.

At an approach like this, the VD zones 1 and 2 would together place a call for the left-turn phase as would zones 4 and 5. Therefore when Zone 2 places a valid call due to a vehicle, if Zone 1 places a call due to the shadow of vehicle in Zone 2, it does not affect the operational performance of the intersection. However, if the shadows of vehicles on Zone 3

activate Zones 1 or 2, it would deteriorate the performance because the left-turn phase would be serviced unnecessarily. Similar reasoning holds for the advance locations. Not only shadows but also turning vehicles could cause similar situations.

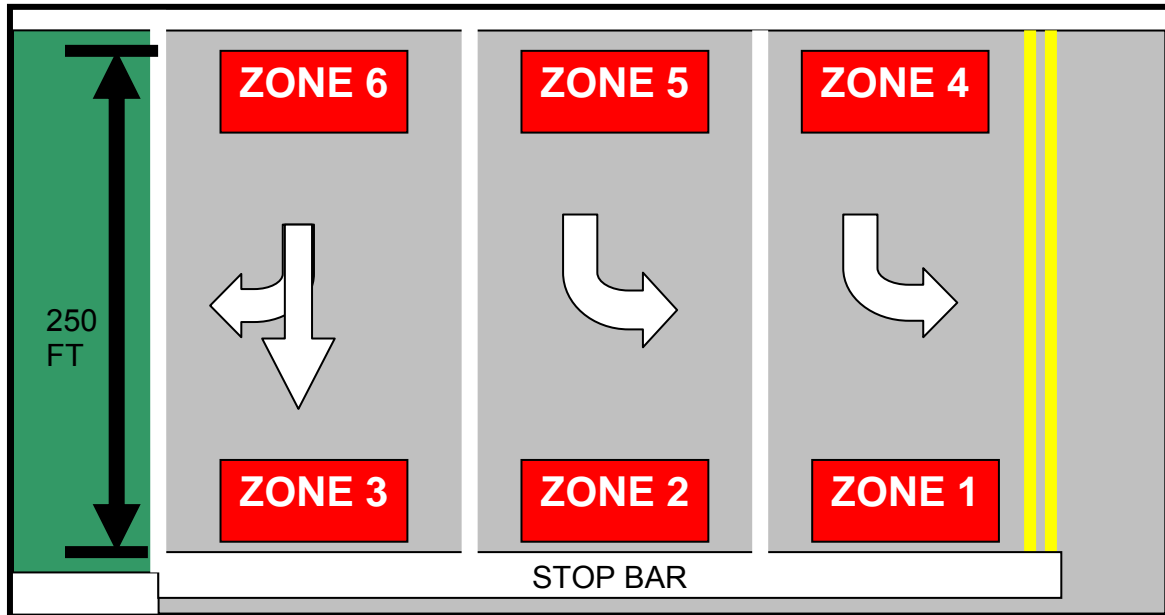

Figure 4-9. Schematic diagram of the study approach.

In the preliminary quantification of potential errors, the activations of Zone 1 (or Zone 4) due to shadows of vehicles on Zone 2 (or Zone 5) are counted as potential false calls. In order to remove the false calls due to the shadows/occlusion, additional logic was applied to Zones 1 and 4, and these results will be included in a separate section that accounts for the operational effects of the lefts turn lanes.

For every potential false call in Zones 1 and 4, it was checked if the loop detector reported a vehicle present on the adjacent lane (Zone 2 and 5 respectively). If so, the potential false call is no longer considered, since the phase requested by this call is the same as the phase requested by the zone the vehicle is traveling on. This logic for shadow/occlusion effect is presented in Figure 4-10.

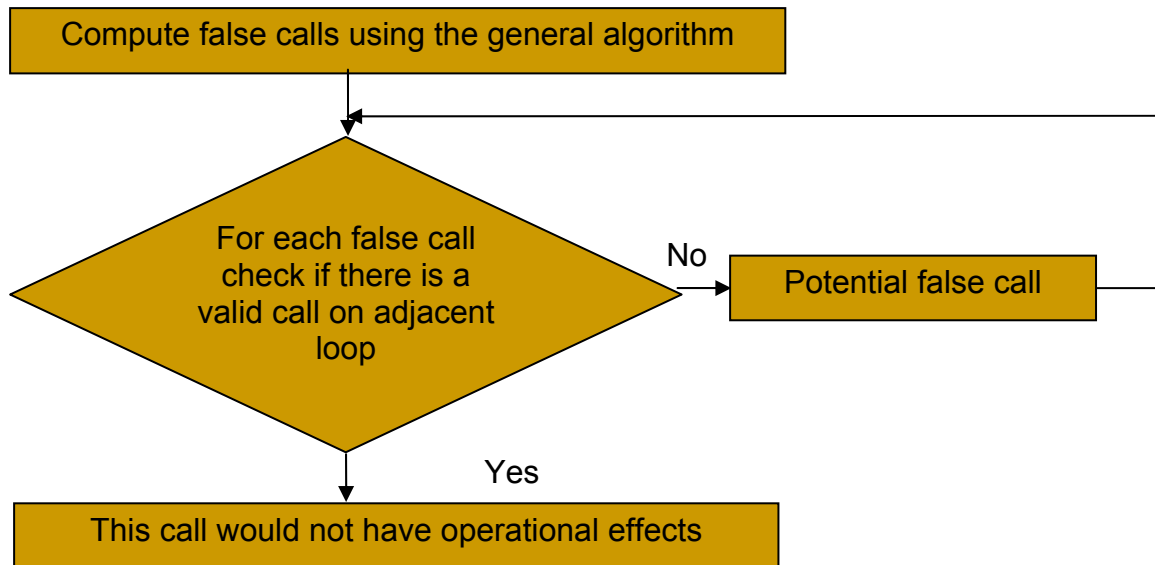

Figure 4-10. Algorithm for shadow/turning vehicle effect on false calls.

4.3.2 Flickering Calls

It was observed that sometimes the shadows of vehicles could cause the adjacent VD zones to “flicker”. In other words the adjacent VD zone places calls of short duration (mostly less than a second) one after another. If each of these calls is considered individually, it would unduly inflate the number of potential false calls. Therefore, potential false calls in close proximity that are of short duration are considered as one potential false call. The actual implementation is presented in Figure 4-11.

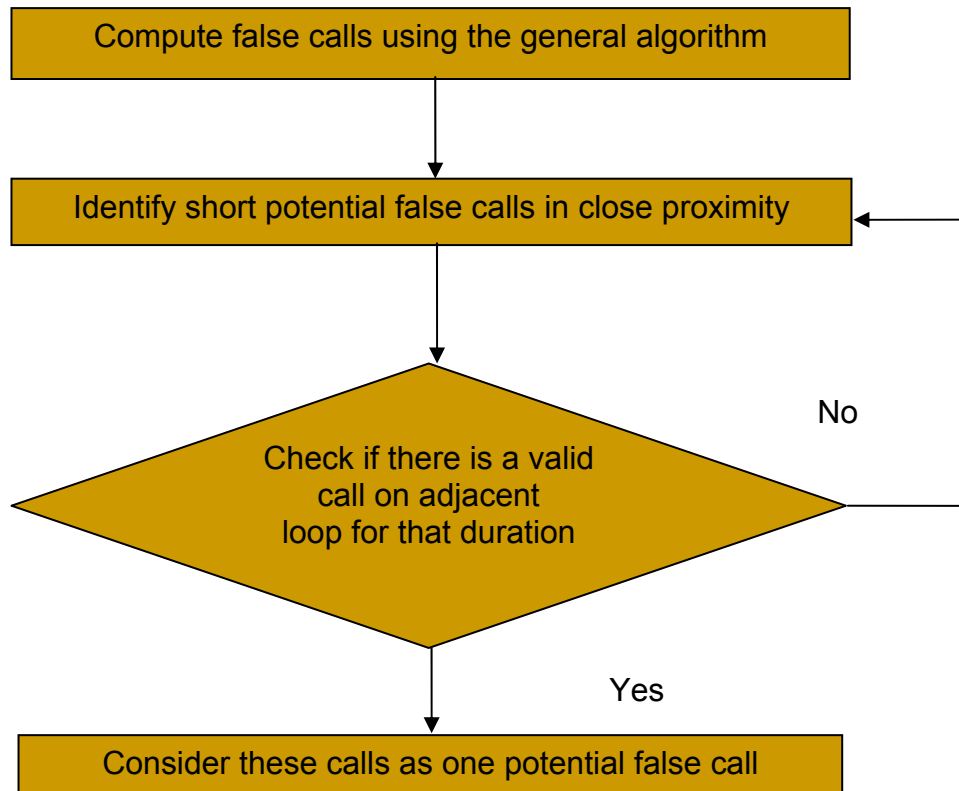

Figure 4-11. Algorithm for flickering.

4.3.3 Vehicles Changing Lanes

At the location of advanced loops, it was observed that a significant fraction of vehicles changed lanes. Due to the lane changing, the VD systems may not correctly detect the vehicle on the same lane as the loop detectors. Consider this scenario: a vehicle in the middle lane changes to the median left-turn lane at the advance location. The loop in the middle lane is activated while the VD systems detect the vehicle in the left-turn lane. The preliminary algorithms would consider this as a potential missed call in the middle lane and a potential false call in the median lane, but these are not actually errors.

To eliminate such discrepancy, when all the three VD systems missed a vehicle but placed calls on the adjacent lane, they were no longer considered as potential missed calls since that would be a clear sign of a vehicle changing lanes. The algorithm is illustrated in Figure 4-12.

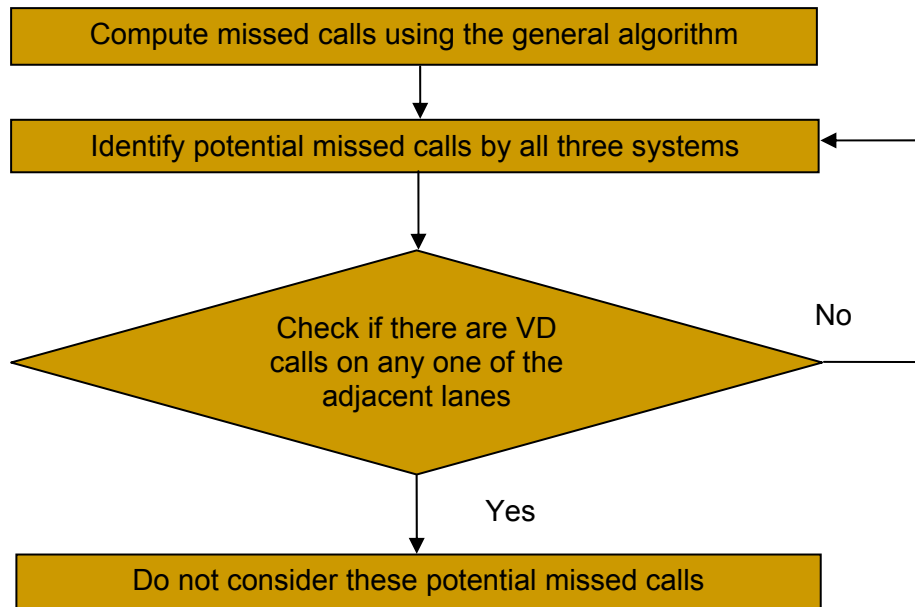

Figure 4-12. Algorithm for vehicles changing Lanes.

4.4 MANUAL VERIFICATION

The algorithms used in the initial and the enhanced analyses relied on automated data reduction to identify potential errors. However, there might still be some situations that may not be handled by the algorithm accurately. For example consider the scenario: a vehicle in the middle lane goes to the median lane at the advance locations; this vehicle is detected by two of the VD systems and the loop as a vehicle in the middle lane, but the third VD system detected it as a vehicle in the median lane. The algorithms used in the initial and the enhanced analyses would consider this as a potential missed call by the third VD system, while in reality it is not. To correctly identify the error and resolve situations like this, manual error verification was performed on all of the potential errors. Video files were observed by a member of the research team to verify if a potential error really was an error.

It should be noted that this manual verification does not require the whole video file to be viewed by a human. Only the times at which the algorithms reported potential errors, were the videos viewed and all the four PMs were verified. This manual verification ensures that the potential errors identified at the automated data reduction stage are actually errors.

4.5 SUMMARY OF PERFORMANCE MEASURES & DATA REDUCTION

For the purpose of comparisons between the VD systems, four Performance Measures (PMs) have been identified: false calls, missed calls, dropped calls, and stuck-on calls. In order to base the conclusions of this study on a large dataset, the data reduction needs to be automated. Therefore, broad definitions for the four performance measures were coded as general algorithms and used to do an initial data reduction. Some situations under which the general algorithms may not compute the PMs correctly were identified. To address those situations, enhanced algorithms were developed and implemented to obtain more refined data reduction results. The computer algorithms were calibrated and validated to ensure an optimal identification of potential errors and reduce the time required in the manual verification stage. Manual verification on every potential error was performed to ensure that the PMs computed by the algorithms are factual. Final evaluation of VD performance is based on manually verified errors and do not rely on the automated analysis only.

CHAPTER 5 RESULTS

This chapter presents the changes in configuration made by the manufacturers/distributors between the initial setup (Setup 1) and the “best” setup (Setup 2), and the effects of those changes in terms of the four performance measures (PMs) previously described. The objective of the changes in the configuration was to improve the performance of the video detection (VD) systems after a preliminary analysis, in terms of the four measures of performance, and video images, were provided to manufacturers/distributors.

Data from cloudy noon and night conditions were utilized for this comparison. No other weather factors such as fog, wind, snow, or others were known to influence the VD performance in the selected datasets. The illumination at the subject approach was not measured, but street lighting was the main source of illumination during night time. Street lights are located at about 40 ft above the street level. There are street lights above each of the mast arms where the traffic signals are installed and also one more light on the curbside at the advance location (at approximately 250ft upstream from the stop bar). No additional light sources from surrounding properties affected the illumination conditions on the subject approach.

Eight datasets from Setup 1 (4 for Sunny Noon and 4 for Night) and ten datasets from Setup 2 (5 for Sunny Noon and 5 for Night) were used. Each dataset is about 1 hour long for Setup 1, about 2 hours long for Setup 2, and represents the operation for that time on that day. Data from four and five different days with the same conditions were included in Setup 1 and 2, respectively. Since the data collection conditions were similar, it is expected to have similar VD performance. The performances are analyzed when the data for four days for Setup 1 and five days for Setup 2 were aggregated into one single dataset to represent each condition. It should be noted that datasets for Setup 2 were selected practically from the same time of the year as Setup 1 to maintain similar conditions and to avoid possible seasonal effects. The performance for each day is also presented in Appendix B of this report, for the reader to observe how much variation was measured from one day to another.

The four performance measures (false calls, missed calls, stuck-on calls, and dropped calls) were obtained by going through the two stage procedure (explained in the Methodology chapter): Automated Identification and Further Enhanced Analysis, and Manual Verification.

As mentioned in Chapter 3, configuration changes were made mainly on Peek and Autoscope, with only very minor changes on Iteris. Results in this section are presented by VD system, analyzing Peek, Autoscope, and Iteris separately and in this order. For each system, the modifications made by the manufacturer/distributor to obtain Setup 2 are discussed first. Then, results from day time data is presented, followed by night time data.

Errors at the stop bar detection zones (at aggregate and individual zone level) are analyzed separately from errors at the advance detection zones. Results from not only individual zones are presented, but also from the average error percentage across the front and the back zones. Averages may be used as a measure of the performance of the VD systems at front and back locations in general.

The tables presented in this section show the percentage of errors for each of the performance measures for Setup 1 and Setup 2. Each table also shows the comparison between the two setups and its results. Z tests for proportions were performed to obtain the statistical differences between Setup 1 and Setup 2, and 90% confidence level was used to determine the test result: increased error, decreased error, or not significantly different. The

Z test was deemed adequate because the sample size for each condition is large enough (in the order of one thousand vehicles or more) to consider it a random representative sample of the relevant population.

5.1 EFFECT OF CONFIGURATION CHANGES IN PEEK

5.1.1 Configuration Changes

Figure 5-1 shows Setups 1 and 2 for Peek VD system. At the time of the modification, the vendor installed the new Peek Unitrak card with the latest video detection software, the camera image was zoomed-in, and the VD zones were changed significantly, as explained below:



Figure 5-1. Configuration setup 1 and setup 2 of Peek.

The following modifications were made to the detection zones:

- Extending Stop Bar Detection Zones over Stop Bar: The stop bar zones in Setup 1 were behind the stop bar. In Setup 2 they were extended past the stop bar to prevent dropped calls. At nighttime, the vehicles are mostly detected by the light coming from their headlights, and as a vehicle approaches the stop bar it is more likely to be detected if the headlights or their reflection fall on the detection zone. For a vehicle stopped at the stop bar, the light from the headlights may not fall on the detection zones if the detection zones are behind the stop bar. Unless locking mode in the traffic controller is “on”, the vehicle calls would be dropped and the approach would not be served.
- Overlapping Stop Bar Zones: In Setup 1, the two detection zones in each of the lanes were not overlapping, while in Setup 2 the zones were overlapping. The non-overlapping detection zones in Setup 1, in some instances, resulted in the upstream detection zone placing a call, then dropping it, and the downstream zone failing to detect the vehicle. This caused dropped calls during day in the stop bar zones 2 and 3.
- Modify Size and Location of Advance Zones: according to the vendor representative, the three detection zones were made thinner and longer to be able to detect the vehicles better. These changes were the result of a significant number of missed calls identified in Setup 1. The manufacturer claimed that the VD system requires more than half of the area of the zone to be occupied for it to detect the vehicle, prompting these modifications to the zones.

5.1.2 Daytime Data

5.1.2.1. Stop Bar Zones

Detection Zones		False Calls		Stuck-on Calls		Missed Calls		Dropped Calls	
		Setup 1	Setup 2	Setup 1	Setup 2	Setup 1	Setup 2	Setup 1	Setup 2
Average of Stop Bar Zones	Number of Calls	705	2043	705	2043	860	2196	860	2196
	Percentage Error	3.7%	7.1%	0.0%	0.0%	1.5%	1.1%	0.5%	0.0%
	Z value, Result	-3.80 , increased		0.00 , not signific.		0.89 , not signific.		2.00 , decreased	
Zone 1	Number of Calls	209	716	209	716	230	703	230	703
	Percentage Error	10.0%	17.5%	0.0%	0.0%	0.4%	0.4%	0.0%	0.0%
	Z value, Result	-2.94 , increased		0.00 , not signific.		0.02 , not signific.		0.00 , not signific.	
Zone 2	Number of Calls	262	684	262	684	351	783	351	783
	Percentage Error	1.1%	3.1%	0.0%	0.0%	0.9%	0.8%	0.6%	0.0%
	Z value, Result	-2.06 , increased		0.00 , not signific.		0.15 , not signific.		1.42 , not signific.	
Zone 3	Number of Calls	234	643	234	643	279	710	279	710
	Percentage Error	0.9%	0.0%	0.0%	0.0%	3.2%	2.1%	0.7%	0.0%
	Z value, Result	1.42 , not signific.		0.00 , not signific.		0.94 , not signific.		1.42 , not signific.	

* The percentage of false and stuck-on calls is based on the number of calls placed by the VD system

* The percentage of missed and dropped calls is based on the number of calls placed by the loops

Table 5.1. Errors for Peek in stop bar zones during daytime.

- **False Calls:** False calls for the three stop bar zones combined is given in the top rows of Table 5.1. On average, the percentage of false calls for the stop bar zones during daytime significantly increased from Setup 1 to Setup 2.

False calls for Zone 1 significantly increased from 10.0% in Setup 1 to 17.5% in Setup 2. Almost all of these false calls were caused by vehicles traveling in the adjacent lane and very few were due to other causes (1.1%). A detailed look at the false calls indicated that they came from left-turning cars on the adjacent lane. Trucks only accounted for ¼ of the total false calls in Setup 2. The remaining 1.1% of the calls were caused by pedestrians and bicyclists crossing the street using the crosswalk

The percentage of false calls in Zone 2 significantly increased from 1.1% in Setup 1 to 3.1% in Setup 2. In Setup 1, all false calls in Zone 2 were caused by vehicles in Zone 3. False calls in Setup 2 were mostly caused by trucks, and in small proportion (0.3%), by pedestrians and bicyclists using the crosswalk. On the other hand, false calls in Zone 3 did not change significantly, with only 0.9% (2 false calls) in Setup 1 and none in Setup 2.

- **Stuck-on Calls:** No stuck-on calls were observed in any of the three zones in Setup 1 or Setup 2.

- **Missed Calls:** Missed calls in the stop bar zones remained low in Setup 2, with an average of 1.1% across the three stop bar zones. No significant changes were observed from Setup 1 to Setup 2. At the individual zone level, the highest percentage of missed calls occurred in Zone 3, with 3.2% (9 vehicles) in Setup 1, and about 2.1% (15 vehicles) in Setup 2. Missed calls for zones 1 and 2 in both setups were lower than 1%. The causes for missed calls were not clear after watching the videos since no particular pattern was observed from the missed vehicles.

- **Dropped Calls:** No dropped calls were found in Setup 2 compared to four dropped calls (0.5%) in Setup 1, two of which were in Zone 2 and two in Zone 3. The increases were not found statistically significant at the zone level, but it was significant on the aggregate level. Modifications made in Setup 2, by extending the detection zones past the stop bar, are believed to have contributed to the elimination of the dropped calls.

- **Overall Effects at Stop bar Zones:** Modifications on stop bar zones had a significant impact in terms of dropped calls and false calls, but none on missed and stuck-on calls (which remained low). False calls increased (from 3.7% to 7.1%) and dropped calls were eliminated, but the overall performance did not greatly improve or deteriorate.

5.1.2.2. Advance Zones

Detection Zones		False Calls		Stuck-on Calls		Missed Calls		Dropped Calls	
		Setup 1	Setup 2	Setup 1	Setup 2	Setup 1	Setup 2	Setup 1	Setup 2
Average of Advance Zones	Number of Calls	504	1832	504	1832	930	2242	930	2242
	Percentage Error	1.0%	6.1%	0.6%	0.2%	37.5%	14.3%	0.0%	0.0%
	Z value, Result	-7.18 , increased		1.05 , not signific.		13.27 , decreased		0.00 , not signific.	
Zone 4	Number of Calls	97	578	97	578	204	661	204	661
	Percentage Error	3.1%	16.8%	0.0%	0.3%	50.5%	19.5%	0.0%	0.0%
	Z value, Result	-5.81 , increased		-1.42 , not signific.		8.08 , decreased		0.00 , not signific.	
Zone 5	Number of Calls	223	675	223	675	431	937	431	937
	Percentage Error	0.0%	2.2%	0.9%	0.1%	35.0%	19.1%	0.0%	0.0%
	Z value, Result	-3.91 , increased		1.15 , not signific.		6.05 , decreased		0.00 , not signific.	
Zone 6	Number of Calls	184	579	184	579	295	644	295	644
	Percentage Error	1.1%	0.0%	0.5%	0.2%	32.2%	1.9%	0.0%	0.0%
	Z value, Result	1.42 , not signific.		0.65 , not signific.		10.93 , decreased		0.00 , not signific.	

* The percentage of false and stuck-on calls is based on the number of calls placed by the VD system

* The percentage of missed and dropped calls is based on the number of calls placed by the loops

Table 5.2. Errors for Peek in Advance Zones during Daytime

- **False Calls:** False calls for the advance zones combined increased significantly from 1% in Setup 1 to 6.1% in Setup 2 (Table 5.2). At the individual zone level, significant increases in false calls were observed in Zones 4 and 5, but not in Zone 6.

In Zone 4, false calls increased in Setup 2 to 16.8% compared to 3.1% in Setup 1. It is noted that for the two setups, all these false calls were caused by vehicles in the adjacent lane. Figure 5-1 shows that Zone 4 in Setup 2 is located closer to the center lane compared to Setup 1. Changes in the configuration of Zone 4, which also included redrawing the detection zone to make it thinner and longer, seemed to have increased the calls from vehicles on the adjacent lane.

False calls for Zone 5 increased from 0% in Setup 1 to 2.2% in Setup 2. Out of 15 false calls, 14 of them were caused by tall vehicles (such as trucks or semi-trailers) traveling in the adjacent right-thru lane, and one call caused by a pedestrian crossing the road. Zone 5 was completely redrawn in Setup 2 compared to Setup 1, making it more sensitive to vehicles and helping reducing the missed calls, but at the cost of an increase in false calls.

- **Stuck-on Calls:** There were no significant changes in the stuck-on calls. Stuck-on calls in the advance zones were very sporadic and represented less than 1% of the total calls from the VD system across the three lanes.

- **Missed Calls:** Missed calls, on average, decreased from 37.5% in Setup 1 to 14.3% in Setup 2 (see Table 5.2). Despite the reduction in missed calls, the number of missed vehicles in Setup 2 was considered high (about 320 vehicles were missed in the advance zones in 10 hours).

At the individual zone level, missed calls in Zone 4 decreased from 50.5% to 19.5%. From the video images, it was observed that missed vehicles were traveling directly over Zone 4, but for unobvious reasons they were not detected. Missed calls in Zone 5 also remained high, even though they changed from 35% in Setup 1 to 19.1% in Setup 2. In Zone 6, missed calls were significantly reduced from about 32.2% in Setup 1 to 1.9% in

Setup 2. Results indicate that modifications in the advance zones made some improvements in terms of missed calls in Setup 2, but did not completely solve this problem.

- **Dropped Calls:** No dropped calls were observed in the advance zones in any of the two setups.
- **Overall Effects in Advance Zones:** The configuration changes resulted in a tradeoff between the reduction in the percentage of missed calls (from 37.5% to 14.3%) and the increase in the percentage of false calls (from 1% to 6.1%). In order to avoid failing to detect vehicles, the VD system was set to be more sensitive, but prone to false calls. It is also noted that the reduction in the missed calls is more pronounced than the increase in false calls, yielding a relatively improved overall performance for the system after the configuration changes.

5.1.3 Nighttime Data

5.1.3.1. Stop Bar Zones

Detection Zones		False Calls		Stuck-on Calls		Missed Calls		Dropped Calls	
		Setup 1	Setup 2	Setup 1	Setup 2	Setup 1	Setup 2	Setup 1	Setup 2
Average of Stop Bar Zones	Number of Calls	737	1616	737	1616	682	1538	682	1538
	Percentage Error	2.0%	8.5%	0.0%	0.0%	1.0%	7.3%	11.4%	0.0%
	Z value, Result	-7.49, increased		0.00, not signific.		-8.15, increased		9.38, decreased	
Zone 1	Number of Calls	197	502	197	502	179	391	179	391
	Percentage Error	2.0%	7.4%	0.0%	0.0%	1.7%	0.0%	10.6%	0.0%
	Z value, Result	-3.46, increased		0.00, not signific.		1.74, decreased		4.60, decreased	
Zone 2	Number of Calls	269	720	269	720	248	561	248	561
	Percentage Error	3.0%	13.8%	0.0%	0.0%	0.8%	0.0%	8.9%	0.0%
	Z value, Result	-6.53, increased		0.00, not signific.		1.42, not signific.		4.90, decreased	
Zone 3	Number of Calls	271	394	271	394	255	586	255	586
	Percentage Error	1.1%	0.5%	0.0%	0.0%	0.8%	19.1%	14.5%	0.0%
	Z value, Result	0.82, not signific.		0.00, not signific.		-10.67, increased		6.57, decreased	

* The percentage of false and stuck-on calls is based on the number of calls placed by the VD system

* The percentage of missed and dropped calls is based on the number of calls placed by the loops

Table 5.3. Errors for Peek in Stop Bar Zones during nighttime.

- **False Calls:** On average, false calls in the stop bar zones increased significantly during nighttime in Setup 2, from 2% to 8.5%. This was the result of significant increases in false calls in Zones 1 and 2.

False calls in Zone 1 increased from 2% to 7.4%, with most of these calls due to vehicles turning left from the center lane. Extending the detection zones past the stop bar was mainly intended to prevent dropped calls, but also affected the frequency of false calls.

In Zone 2, false calls increased from 3% to 13.8%. The false calls in nighttime were due to the reflection of headlights from vehicles approaching Zone 1.

- **Stuck-on Calls:** No stuck-on calls were observed in the stop bar zones in Setup 1 or Setup 2 in nighttime.

- **Missed Calls:** Missed calls for all stop bar zones combined increased from 1% in Setup 1 to 7.3% in Setup 2. This increase was mainly due to an increase in missed calls in Zone 3 that went from 0.8% in Setup 1 to 19.1% in Setup 2. The missed calls were slightly reduced in Zone 1.

The causes for the significant increase of missed calls in Zone 3 were unobvious after a visual inspection of the video images. Most of the missed vehicles travelled directly over the zone and continued thru the intersection, with no clear cause for the VD system to

miss the detection. About 10% of the missed vehicles were right turners, which could be missed because their headlights pointed towards to the crossing street after vehicles took position to make the turn, falling out of the detection zone.

It should be noted that Zone 3 was completely modified from its initial shape and location in Setup 1. In Setup 2, Zone 3 consisted of only one zone (not multiple or overlapping zones as it was in Setup 1), it was shorter, and covered some area past the stop bar. Missed calls during daytime in Zone 3 Setup 2 (2.1%) were similar to those in Setup 1 (3.2%), but they occurred at a much higher rate during nighttime (19.1%).

- **Dropped Calls:** Dropped calls in Setup 1 were on average 11.4% for all stop bar zones combined, and they were completely eliminated in Setup 2. All three front zones had considerably high percentages of dropped calls (at least 8.9%) in Setup 1 and after the configuration changes they dropped to 0%. Extending the front zones past the stop bar was the key to this improvement, since the headlight of most stopped vehicles were most likely to fall into the zone.

- **Overall Effects in Stop Bar Zones:** Changes in configuration in the stop bar zones completely eliminated the dropped calls in nighttime; however, these changes increased false calls (from 2% to 8.5%) and missed calls (from 1% to 7.3%). Overall performance of Setup 2 showed a tradeoff between reducing dropped calls and increasing false calls due to turning vehicles and headlight reflection, plus some new issues with missed calls in Zone 3.

5.1.3.2. Advance Zones

Detection Zones		False Calls		Stuck-on Calls		Missed Calls		Dropped Calls	
		Setup 1	Setup 2	Setup 1	Setup 2	Setup 1	Setup 2	Setup 1	Setup 2
Average of Advance Zones	Number of Calls	601	1432	601	1432	717	1623	717	1623
	Percentage Error	1.5%	3.3%	0.0%	0.0%	12.3%	1.9%	0.0%	0.0%
	Z value, Result	-2.61, increased		0.00, not signific.		8.14, decreased		0.00, not signific.	
Zone 4	Number of Calls	137	370	137	370	159	348	159	348
	Percentage Error	0.0%	12.4%	0.0%	0.0%	13.2%	0.6%	0.0%	0.0%
	Z value, Result	-7.24, increased		0.00, not signific.		4.64, decreased		0.00, not signific.	
Zone 5	Number of Calls	258	519	258	519	295	686	295	686
	Percentage Error	2.7%	0.0%	0.0%	0.0%	6.4%	2.9%	0.0%	0.0%
	Z value, Result	2.68, decreased		0.00, not signific.		2.25, decreased		0.00, not signific.	
Zone 6	Number of Calls	206	543	206	543	263	589	263	589
	Percentage Error	1.0%	0.2%	0.0%	0.0%	18.3%	1.5%	0.0%	0.0%
	Z value, Result	1.11, not signific.		0.00, not signific.		6.86, decreased		0.00, not signific.	

* The percentage of false and stuck-on calls is based on the number of calls placed by the VD system

* The percentage of missed and dropped calls is based on the number of calls placed by the loops

Table 5.4. Errors for Peek in Advance Zones during Nighttime

- **False Calls:** Average false calls for all advance zones combined increased from 1.5% to 3.3%. However, changes in false calls at the individual zone level did not follow a single trend. In Zone 4, false calls increased significantly (from 0% to 12.4%) due to the headlights of vehicles approaching on the left-most lane but traveling in the center lane. In Zone 5, false calls decreased from 2.7% to 0%, and no significant changes were observed in Zone 6, where false calls remained lower than 1%.

- **Stuck-on Calls:** No stuck-on calls were observed in Setup 1 or Setup 2 in the advance zones.

- **Missed Calls:** Missed calls across all three detections zones decreased from 12.3% in Setup 1 to 1.9% in Setup 2. All three detections zones showed a significant decrease in

missed calls. There seems to be a tradeoff between the improvement in missed calls and the increase in false calls, as it was also noted for the advance zones in daytime.

- **Dropped Calls:** No dropped calls were observed in the advance locations in Setup 1 or Setup 2.
- **Overall Effects in Advance Zones:** Configuration changes resulted in a tradeoff between false and missed calls. The overall performance improved because the reduction in missed calls (>10% reduction) was far greater than the increase of false calls (<2% increase). Stuck-on calls and dropped calls were not a concern in the initial setup and were unaffected by the configuration changes.

5.1.4 Operational Effects of Dual Left Turn Lanes in False Calls

As mentioned in Chapter 3, the instrumented approach of the intersection under study has one shared right-thru lane and two left turn lanes. The fact that the detection zones in the left turn lanes would call the same left turn phase may mask some of the errors of VD system, if the detection in the two lanes is “tied” together. For this particular condition, the false calls that are placed on the left-most lane by vehicles traveling in the center lane (both are left turn lanes) may not have practically any effect in the efficiency of the operation if the two lanes call the same signal phase. It is clear that this consideration only applies to false calls, since missed, dropped, and stuck-on calls will affect performance of the signal regardless of the phasing.

If such false calls (in Zones 1 and 4 caused by vehicles in center lane) are removed from the analysis, then the false calls in Zone 1 show a low increase from Setup 1 to Setup 2 (less than 2%), compared to an increase of 7% in daytime and 5.4% in nighttime when the analysis included all false calls (see Table 5.5). Regarding Zone 4, no significant change would be observed if false calls from the vehicles in the center lane are not considered. This is in sharp contrast with all false calls included, where increases of 13.7% and 12.4% occurred in daytime and nighttime, respectively.

Zone		False Calls not Placed by Vehicles in Adjacent Lane			
		Daytime		Nighttime	
		Setup 1	Setup 2	Setup 1	Setup 2
Zone 1	Calls (Total number)	209	716	197	502
	False Calls (%)	0.0%	1.1%	0.0%	1.6%
	Z value, Result	-2.84 , increased		-2.85 , increased	
Zone 4	Calls (Total number)	97	578	137	370
	False Calls (%)	0.0%	0.0%	0.0%	0.0%
	Z value, Result	0.00 , not signif.		0.00 , not signif.	

* The percentage of false calls is based on the number of calls placed by the VD system

Table 5.5. Peek False Calls not Caused by Adjacent Vehicles

Thus, for practical considerations, if false calls from vehicles on the adjacent lane are removed, modifications to the configuration of Peek did not increase false calls in Zone 4, with only minor increases in Zone 1. Note that for different layouts with single left turn lane these considerations do not apply and false calls from adjacent lane will affect the operation efficiency of the intersection.

5.2 EFFECT OF CONFIGURATION CHANGES IN AUTOSCOPE

5.2.1 Configuration Changes

Changes between Setup 1 and Setup 2 in Autoscope included revisions to the properties as well as minor changes to the location and length of the detection zones. Figure 5-2 shows a snapshot of an image from the Autoscope camera before and after the modifications.



Figure 5-2. Configuration setup 1 and setup 2 of Autoscope.

The manufacturer indicated that the following changes to the system configuration were made:

- The stop bar detectors were changed to Type 9 detector, which helps eliminating false calls due to stationary objects. This is typically used to detect motion during the green phase and an object is not moving. A delay time of 1/2 second was also used to compensate for camera movement.
- The detector refresh time was lowered to 90 seconds. This sets the guaranteed minimum amount of time an object can be stationary before becoming part of the background. Useful for slow moving shadows from fixed objects such as buildings.
- The advance detectors were changed to count detectors and shadow processing was implemented to minimize the effect of camera movement. Count detectors are smaller and placed horizontally across the lane.
- The position and location of some detectors were also re-sketched or modified.

5.2.2 Daytime Data

5.2.2.1. Stop Bar Zones

Detection Zones		False Calls		Stuck-on Calls		Missed Calls		Dropped Calls	
		Setup 1	Setup 2	Setup 1	Setup 2	Setup 1	Setup 2	Setup 1	Setup 2
Average of Stop Bar Zones	Number of Calls	604	1645	604	1645	860	2196	860	2196
	Percentage Error	3.0%	2.2%	0.2%	0.8%	0.0%	0.4%	0.0%	0.0%
	Z value, Result	0.93 , not signific.		-2.28 , increased		-3.01 , increased		0.00 , not signific.	
Zone 1	Number of Calls	183	514	183	514	230	703	230	703
	Percentage Error	7.1%	5.3%	0.0%	1.9%	0.0%	0.9%	0.0%	0.0%
	Z value, Result	0.86 , not signific.		-3.19 , increased		-2.46 , increased		0.00 , not signific.	
Zone 2	Number of Calls	218	588	218	588	351	783	351	783
	Percentage Error	1.4%	1.7%	0.0%	0.3%	0.0%	0.4%	0.0%	0.0%
	Z value, Result	-0.34 , not signific.		-1.42 , not signific.		-1.73 , increased		0.00 , not signific.	
Zone 3	Number of Calls	203	543	203	543	279	710	279	710
	Percentage Error	1.0%	0.0%	0.5%	0.2%	0.0%	0.0%	0.0%	0.0%
	Z value, Result	1.42 , not signific.		0.59 , not signific.		0.00 , not signific.		0.00 , not signific.	

* The percentage of false and stuck-on calls is based on the number of calls placed by the VD system

* The percentage of missed and dropped calls is based on the number of calls placed by the loops

Table 5.6. Errors for Autoscope in Stop Bar Zones during daytime.

- **False Calls:** Changes made in Autoscope configuration did not have any significant effect in false calls in the front zones (Table 5.6). The average percentage of false calls for all zones combined remained low and similar in Setup 2 (2.2%) compared to Setup 1 (3%). False calls in Setup 2 were highest for Zone 1 (5.3%) compared to Zones 2 (1.7%) and 3 (0%). Most false calls in Zone 1 (60%) were caused by vehicles occupying portions of the zone while waiting to turn left (tall vehicles) or while turning (small vehicles) from the center lane.

- **Stuck-on Calls:** Changes in stuck-on calls for all stop bar zones combined were small (from 0.2% to 0.8%) but statistically significant. Stuck-on calls increased in Zone 1 only, changing from 0% to 1.9% (10 stuck-on calls). In Zones 2 and 3, stuck-on calls did not change significantly and remained very low in both setups (<0.5%).

- **Missed Calls:** Missed calls were very infrequent but the average of all stop bar zones combined had a slight increase (0.4%) on Setup 2 compared to Setup 1. This increase was due to an increase in the missed calls in Zone 1, changing from no vehicles missed in Setup 1 to 6 vehicles missed (0.9%) in 10 hours in Setup 2, and also due to 3 vehicles missed (0.4%) in Zone 2. From the recorded video images, no particular patterns or situations were observed to have caused the missed calls.

- **Dropped Calls:** No dropped calls were found in any of the setups in the stop bar zones.

- **Overall Effects in Stop Bar Zones:** Modifications in stop bar zones resulted in very small, but statistically significant, increase in stuck-on calls (about 13 vehicles in 1645 vehicles) and missed calls (9 vehicles in 2195 vehicles). False calls remained low (2.2% on average) in Setup 2, and no dropped calls were observed.

5.2.2.2. Advance Zones

Detection Zones		False Calls		Stuck-on Calls		Missed Calls		Dropped Calls	
		Setup 1	Setup 2	Setup 1	Setup 2	Setup 1	Setup 2	Setup 1	Setup 2
Average of Advance Zones	Number of Calls	841	2077	841	2077	930	2242	930	2242
	Percentage Error	10.9%	2.3%	0.2%	0.4%	11.6%	3.8%	0.0%	0.0%
	Z value, Result	7.71 , decreased		-0.68 , not signific.		6.95 , decreased		0.00 , not signific.	
Zone 4	Number of Calls	202	590	202	590	204	661	204	661
	Percentage Error	40.1%	4.2%	0.0%	0.5%	38.2%	10.0%	0.0%	0.0%
	Z value, Result	10.09 , decreased		-1.73 , increased		7.84 , decreased		0.00 , not signific.	
Zone 5	Number of Calls	366	850	366	850	431	937	431	937
	Percentage Error	3.0%	1.9%	0.3%	0.6%	6.5%	2.0%	0.0%	0.0%
	Z value, Result	1.11 , not signific.		-0.83 , not signific.		3.51 , decreased		0.00 , not signific.	
Zone 6	Number of Calls	273	637	273	637	295	644	295	644
	Percentage Error	0.0%	0.9%	0.4%	0.0%	0.7%	0.0%	0.0%	0.0%
	Z value, Result	-2.46 , increased		1.00 , not signific.		1.42 , not signific.		0.00 , not signific.	

* The percentage of false and stuck-on calls is based on the number of calls placed by the VD system

* The percentage of missed and dropped calls is based on the number of calls placed by the loops

Table 5.7. Errors for Autoscope in Advance Zones during daytime.

- **False Calls:** On average, for all advance zones combined, a significant decrease from 10.9% to 2.3% was observed for false calls. This decrease comes from an improvement in Zone 4, which reduced false calls from 40.1% in Setup 1 to 4.2% in Setup 2. A slight increase in false calls was observed in Zone 6 (from 0% to 0.9%), and no significant change occurred in Zone 5 which remained low at 1.9%.
- **Stuck-on Calls:** Stuck-on calls did not change significantly and remained low in Setup 2, with an average of 0.4% for all advance zones combined.
- **Missed Calls:** Missed calls decreased significantly in the advance zones, changing from 11.6% to 3.8% on average. The highest improvement was observed in Zone 4, where missed calls were reduced from 38.2% to 10%, representing a total of 66 vehicles missed in 10 hours in Setup 2. Missed vehicles in Setup 2 in Zone 5 were low (2%) compared to missed vehicles in Setup 1 (6.5%), and no missed vehicles were observed in Zone 6. The reduction in missed calls is clearly related to the modifications in Setup 2 in Zones 4 and 5, by moving them from the edge of the traveled lane toward the center of the lane.
- **Dropped Calls:** Dropped calls were not observed in any of the setups in the advance zones.
- **Overall Effects in Advance Zones:** Although the configuration changes improved the overall performance of Autoscope in the advance zones by reducing false calls to 2.3% (from 10.9%) and missed calls to 3.8% (from 11.6%), the percentage of missed call may still be considered high and raise some concerns in the overall performance of VD system. Stuck-on calls were very low (<1%), and there were no dropped calls.

5.2.3 Nighttime Data

5.2.3.1. Stop Bar Zones

Detection Zones		False Calls		Stuck-on Calls		Missed Calls		Dropped Calls	
		Setup 1	Setup 2	Setup 1	Setup 2	Setup 1	Setup 2	Setup 1	Setup 2
Average of Stop Bar Zones	Number of Calls	686	1801	686	1801	682	1538	682	1538
	Percentage Error	19.0%	29.5%	0.6%	0.2%	0.6%	0.0%	0.0%	0.0%
	Z value, Result	-5.71 Increased		1.36, not signific.		2.00 Decreased		0.00, not signific.	
Zone 1	Number of Calls	159	366	159	366	179	391	179	391
	Percentage Error	1.9%	9.3%	0.6%	0.0%	1.1%	0.0%	0.0%	0.0%
	Z value, Result	-3.97 Increased		1.00, not signific.		1.42, not signific.		0.00, not signific.	
Zone 2	Number of Calls	291	707	291	707	248	561	248	561
	Percentage Error	32.6%	34.7%	0.7%	0.3%	0.0%	0.0%	0.0%	0.0%
	Z value, Result	-0.61, not signific.		0.77, not signific.		0.00, not signific.		0.00, not signific.	
Zone 3	Number of Calls	236	728	236	728	255	586	255	586
	Percentage Error	13.6%	34.6%	0.4%	0.1%	0.8%	0.0%	0.0%	0.0%
	Z value, Result	-7.40 Increased		0.64, not signific.		1.42, not signific.		0.00, not signific.	

* The percentage of false and stuck-on calls is based on the number of calls placed by the VD system

* The percentage of missed and dropped calls is based on the number of calls placed by the loops

Table 5.8. Errors for Autoscope in Stop Bar Zones during Nighttime

- **False Calls:** False calls for all stop bar zones combined increased from 19% in Setup 1 to 29.5% in Setup 2. This increase was due to significant increases, mainly in Zone 3 (from 13.6% to 34.6%) and to a lesser degree in Zone 1 (from 1.9% to 9.4%). By moving the VD Zone 3 towards the center lane, this zone detected more of the headlight reflection from vehicles in the center lane (Zone 2) compared to Setup 1, increasing the false calls.

Similarly, the increase in false calls in Zone 1 was due to the greater sensitivity of the zone to the reflection of vehicle headlights approaching in the center lane (Zone 2). This issue was observed in much lower proportion in Setup 1, but became important in Setup 2. It was noted that one of the zones drawn in Setup 2 for Zone 1 (arrow shaped) is more upstream than in Setup 1 and picked up with more ease the contrast change caused by the headlights of approaching vehicles.

- **Stuck-on Calls:** No significant changes were observed in the stuck-on calls in the stop bar zones. Stuck-on calls remained very low, accounting for only 0.2% of the total number of calls placed by the VD system for all zones combined.

- **Missed Calls:** Missed calls were completely eliminated in Setup 2 during night conditions, from a total of 4 vehicles missed in Setup 1 in the stop bar zones. Even though changes were not significant at the individual zone level, the total decrease in missed calls for all stop bar zones combined was significant.

- **Dropped Calls:** No dropped calls were observed in any of the two setups in the stop bar zones.

- **Overall Effects in Stop Bar Zones:** Configuration changes in Autoscope resulted in the elimination of missed calls in the stop bar zones from 0.6% (4 missed vehicles) in Setup 1, but at the expense of increasing false calls by about 10% in the three stop bar zones combined (from 19% to 29.5%). No significant effect was observed in stuck-on calls, which remained very low, or dropped calls, which remained zero.

5.2.3.2. Advance Zones

Detection Zones		False Calls		Stuck-on Calls		Missed Calls		Dropped Calls	
		Setup 1	Setup 2	Setup 1	Setup 2	Setup 1	Setup 2	Setup 1	Setup 2
Average of Advance Zones	Number of Calls	765	2066	765	2066	717	1623	717	1623
	Percentage Error	19.9%	25.8%	0.1%	0.1%	5.7%	0.1%	0.0%	0.0%
	Z value, Result	-3.39 Increased		0.23 , not signific.		6.42 Decreased		0.00 , not signific.	
Zone 4	Number of Calls	118	332	118	332	159	348	159	348
	Percentage Error	0.0%	0.9%	0.0%	0.0%	23.9%	0.0%	0.0%	0.0%
	Z value, Result	-1.74 Increased		0.00 , not signific.		7.04 Decreased		0.00 , not signific.	
Zone 5	Number of Calls	375	764	375	764	295	686	295	686
	Percentage Error	29.6%	18.1%	0.3%	0.0%	1.0%	0.1%	0.0%	0.0%
	Z value, Result	4.21 Decreased		1.00 , not signific.		1.44 , not signific.		0.00 , not signific.	
Zone 6	Number of Calls	272	970	272	970	263	589	263	589
	Percentage Error	15.1%	40.3%	0.0%	0.2%	0.0%	0.2%	0.0%	0.0%
	Z value, Result	-9.40 Increased		-1.41 , not signific.		-1.00 , not signific.		0.00 , not signific.	

* The percentage of false and stuck-on calls is based on the number of calls placed by the VD system

* The percentage of missed and dropped calls is based on the number of calls placed by the loops

Table 5.9. Errors for Autoscope in Advance Zones during nighttime.

- **False Calls:** On average, false calls increased in the advance zones compared to Setup 1. From about 19.9% false calls in Setup 1 it changed to 25.8% in Setup 2, mostly due to increases in Zone 6 (from 15.1% to 40.3%), followed by a slight increase in Zone 4 (from 0% to 0.9%). Albeit the increasing trend of zones 4 and 6, Zone 5 showed a decrease in false calls.

Zone 6 was moved from being close to the center of the lane to a location towards the adjacent lane, making it more sensitive to headlight reflection from approaching vehicles in the center lane and even in the median lane. This situation is similar to that described for Zone 3, where most vehicles approaching in the center lane placed a false call in Zone 6, including some vehicles changing lanes towards Zone 4 that created a headlight reflection long enough to reach Zone 6.

On the other hand, the decrease in Zone 5 was significant (from 29.6% to 18.1%). This decrease was due to the reduction in Zone 5 flickering when a vehicle was approaching in the center lane.

- **Stuck-on Calls:** No changes were observed in stuck-on calls, which occurred only twice in 10 hours of data in Setup 2, compared to only one stuck-on call in Setup 1.
- **Missed Calls:** For all zones combined, missed calls decreased significantly, from about 5.7% (41 vehicles missed) to only 0.1% (2 vehicles missed). This reduction was the result of eliminating missed calls from Zone 4, which changed from 23.9% to 0%. Zones 5 and 6 also reduced the percentage of missed calls in Setup 2, but not in a significant way since the percentages were already very small (<1% missed).
- **Dropped Calls:** No dropped calls were observed in Setup 1 or Setup 2.
- **Overall Effects in Advance Zones:** In nighttime in the advance zones, the missed calls decreased to 0.1% from 5.7%, but the false calls increased from 19.9% to 25.8%. The modifications did not have significant impact on stuck-on calls, which remained at 0.1%, and dropped calls, which did not exist in any of the two setups.

5.2.4 Operational Effects of Dual Left Turn Lanes in False Calls

As mentioned in Chapter 3, the instrumented approach of the intersection under study has one shared right-thru lane and two left turn lanes. The fact that the detection zones in the left turn lanes would call the same left turn phase may mask some of the errors of VD system, if the detection in the two lanes is “tied” together. For this particular condition, the false calls that are placed on the left-most lane by vehicles traveling in the center lane (both are left turn lanes) may not have practically any effect in the efficiency of the operation if the two lanes call the same signal phase. It is clear that this consideration only applies to false calls, since missed, dropped, and stuck-on calls will affect performance of the signal regardless of the phasing.

If such false calls (in Zones 1 and 4 caused by vehicles in center lane) are removed from the analysis (see Table 5.10), then the false calls in Zones 1 and 4 are $\leq 1\%$ in daytime and nighttime, and both Setups 1 and 2. For Zone 1, a low increase (1%) in daytime was observed, while no change occurred in nighttime from Setup 1 to Setup 2. After a manual verification of the videos, it was possible to establish that during daytime the 1% increase in false calls in Zone 1 was due to five false calls, three of which were caused by pedestrians, one by a short cloudy-sun-cloudy variation that created a sudden contrast change in Zone 1, and one due to reasons not clear from the videos. Regarding Zone 4, a significant change was observed during daytime, from 37.6% in Setup 1 to 0.5% in Setup 2. All false calls during daytime in Setup 1 occurred in a short period of time because of a small vibration in the camera image, possibly due to low speed winds.

Zone		False Calls not Placed by Vehicles in Adjacent Lane			
		Daytime		Nighttime	
		Setup 1	Setup 2	Setup 1	Setup 2
Zone 1	Calls (Total number)	183	514	159	366
	False Calls (%)	0.0%	1.0%	0.0%	0.0%
	Z value, Result	-2.24 , increased		0.00 , not signif.	
Zone 4	Calls (Total number)	202	590	118	332
	False Calls (%)	37.6%	0.5%	0.0%	0.3%
	Z value, Result	10.82 , decreased		-1.00 , not signif.	

* The percentage of false calls is based on the number of calls placed by the VD system

Table 5.10. Autoscope false calls not caused by adjacent vehicles.

5.3 EFFECT OF CONFIGURATION CHANGES IN ITERIS

5.3.1 Configuration Changes

Changes between Setup 1 and Setup 2 in Iteris were limited to only a very slight modification in the size of the stop bar zones. Figure 5-3 shows an image from Setup 1. No image from Setup 2 is provided since no observable differences from Setup 1 could be found from the video images alone.



Figure 5-3. Configuration setup 1 of Iteris.

5.3.2 Daytime Data

5.3.2.1. Stop Bar Zones

Detection Zones		False Calls		Stuck-on Calls		Missed Calls		Dropped Calls	
		Setup 1	Setup 2	Setup 1	Setup 2	Setup 1	Setup 2	Setup 1	Setup 2
Average of Stop Bar Zones	Number of Calls	708	1868	708	1868	860	2196	860	2196
	Percentage Error	10.6%	8.9%	0.0%	0.0%	0.0%	0.1%	0.0%	0.0%
	Z value, Result	1.28, not signific.		0.00, not signific.		-1.41, not signific.		0.00, not signific.	
Zone 1	Number of Calls	243	663	243	663	230	703	230	703
	Percentage Error	25.9%	19.3%	0.0%	0.0%	0.0%	0.0%	0.0%	0.0%
	Z value, Result	2.06, decreased		0.00, not signific.		0.00, not signific.		0.00, not signific.	
Zone 2	Number of Calls	246	646	246	646	351	783	351	783
	Percentage Error	4.5%	5.6%	0.0%	0.0%	0.0%	0.1%	0.0%	0.0%
	Z value, Result	-0.69, not signific.		0.00, not signific.		-1.00, not signific.		0.00, not signific.	
Zone 3	Number of Calls	219	559	219	559	279	710	279	710
	Percentage Error	0.5%	0.4%	0.0%	0.0%	0.0%	0.1%	0.0%	0.0%
	Z value, Result	0.19, not signific.		0.00, not signific.		-1.00, not signific.		0.00, not signific.	

* The percentage of false and stuck-on calls is based on the number of calls placed by the VD system

* The percentage of missed and dropped calls is based on the number of calls placed by the loops

Table 5.11. Errors for Iteris in Stop Bar Zones during Daytime

- **False Calls:** No significant changes were found for all stop bar zones combined. The percentage of false calls remained similar, with 10.6% in Setup 1 compared to 8.9% in Setup 2. However, results for individual zones showed a decrease in false calls in Zone 1,

from 25.9% in Setup 1 to 19.3% in Setup 2. Zones 2 and 3 did not change significantly and had less false calls than Zone 1, with 5.6% and 0.4% in Setup 2.

- **Stuck-on Calls:** No stuck-on calls were found at the stop bar zones during daytime in Setup 1 or Setup 2 for Iteris.
- **Missed Calls:** Two missed calls were found in Iteris stop bar zones in Setup 2 (one in Zone 2 and one in Zone 3), compared to none in Setup 1. These changes were found not statistically significant for individual zones or all zones together, and represented only a fraction of a percentage from the total volume in the two conditions (0.1%).
- **Dropped Calls:** No dropped calls were found in any of the setups in the stop bar zones.
- **Overall Effects in Stop Bar Zones:** The small changes in the stop bar zones in Iteris did not have significant effects in the performance of the system in any of the four types of errors.

5.3.2.2. Advance Zones

Detection Zones		False Calls		Stuck-on Calls		Missed Calls		Dropped Calls	
		Setup 1	Setup 2	Setup 1	Setup 2	Setup 1	Setup 2	Setup 1	Setup 2
Average of Advance Zones	Number of Calls	942	2333	942	2333	930	2242	930	2242
	Percentage Error	8.5%	10.9%	0.0%	0.0%	0.8%	2.4%	0.0%	0.0%
	Z value, Result	-2.15 , increased		0.00 , not signific.		-3.85 , increased		0.00 , not signific.	
Zone 4	Number of Calls	236	850	236	850	204	661	204	661
	Percentage Error	17.8%	24.0%	0.0%	0.0%	1.5%	0.0%	0.0%	0.0%
	Z value, Result	-2.14 , increased		0.00 , not signific.		1.74 , decreased		0.00 , not signific.	
Zone 5	Number of Calls	425	849	425	849	431	937	431	937
	Percentage Error	8.7%	5.1%	0.0%	0.0%	0.9%	5.7%	0.0%	0.0%
	Z value, Result	2.33 , decreased		0.00 , not signific.		-5.34 , increased		0.00 , not signific.	
Zone 6	Number of Calls	281	634	281	634	295	644	295	644
	Percentage Error	0.4%	1.1%	0.0%	0.0%	0.0%	0.2%	0.0%	0.0%
	Z value, Result	-1.37 , not signific.		0.00 , not signific.		-1.00 , not signific.		0.00 , not signific.	

* The percentage of false and stuck-on calls is based on the number of calls placed by the VD system

* The percentage of missed and dropped calls is based on the number of calls placed by the loops

Table 5.12. Errors for Iteris in Advance Bar Zones during daytime.

- **False Calls:** An increase in false calls was observed for all advance zones combined, changing from 8.5% in Setup 1 to 10.9% in Setup 2. These overall changes reflect the increase in false calls in Zone 1, from 17.8% to 24%, and the reduction (in a lesser degree) of false calls in Zone 2 from 8.7% to 5.1%. No significant changes were observed in Zone 3, which had 1.1% of false calls in Setup 2, compared to 0.4% in Setup 1.

The increase in false calls for Zone 4 in Setup 2 was due to the high number of vehicles that occupied parts of the image over Zone 4 when traveling on the center lane. Regarding Zone 5, a lower number of tall vehicles, such as trucks, traveled on the adjacent lane (shared right-thru lane) in the data from Setup 2 compared to Setup 1, causing the small decrease in false calls.

- **Stuck-on Calls:** No stuck-on calls were found in the advance zones during daytime in Setup 1 or Setup 2.
- **Missed Calls:** An overall increase in missed calls for all advance zones combined, from 0.8% to 2.4%, resulted from opposing trends at the individual zone level. Missed calls increased in Zone 5 from 0.9% (4 vehicles) in Setup 1 to 5.7% (53 vehicles) in Setup 2, while a decrease was observed in Zone 4, from 1.5% (3 vehicles) in Setup 1 to 0% in Setup 2.

After reviewing the video images from both setups, it was not possible to identify the causes of these changes. Missed vehicles traveled in similar patterns in both setups and no distinct characteristics from missed vehicles were found.

- **Dropped Calls:** No dropped calls were found in Iteris advance zones during daytime in Setup 1 or Setup 2.
- **Overall Effects in Advance Zones:** Significant but relatively small increases in false calls (from 8.5% to 10.9%) and missed calls (from 0.8% to 2.4%) for the three advance zones combined were found, even though no changes were made to these zones from Setup 1 to Setup 2. It is noted that these changes respond to local changes at individual zones with opposite trends. Also, a tradeoff between false and missed calls was observed within Zones 4 and 5: Zone 4 increased false calls but decreased missed calls, and Zone 5 decreased false calls but it also increased missed calls.

5.3.3 Nighttime Data

5.3.3.1. Stop Bar Zones

Detection Zones		False Calls		Stuck-on Calls		Missed Calls		Dropped Calls	
		Setup 1	Setup 2	Setup 1	Setup 2	Setup 1	Setup 2	Setup 1	Setup 2
Average of Stop Bar Zones	Number of Calls	622	1411	622	1411	682	1538	682	1538
	Percentage Error	3.9%	6.2%	0.2%	2.5%	0.1%	0.0%	0.0%	0.0%
	Z value, Result	-2.30 Increased		-5.22 Increased		1.00 , not signific.		0.00 , not signific.	
Zone 1	Number of Calls	182	383	182	383	179	391	179	391
	Percentage Error	10.4%	11.0%	0.0%	0.0%	0.0%	0.0%	0.0%	0.0%
	Z value, Result	-0.19 , not signific.		0.00 , not signific.		0.00 , not signific.		0.00 , not signific.	
Zone 2	Number of Calls	225	513	225	513	248	561	248	561
	Percentage Error	2.2%	5.5%	0.4%	5.8%	0.4%	0.0%	0.0%	0.0%
	Z value, Result	-2.30 Increased		-4.79 Increased		1.00 , not signific.		0.00 , not signific.	
Zone 3	Number of Calls	215	515	215	515	255	586	255	586
	Percentage Error	0.0%	3.3%	0.0%	1.0%	0.0%	0.0%	0.0%	0.0%
	Z value, Result	-4.19 Increased		-2.24 Increased		0.00 , not signific.		0.00 , not signific.	

* The percentage of false and stuck-on calls is based on the number of calls placed by the VD system

* The percentage of missed and dropped calls is based on the number of calls placed by the loops

Table 5.13. Errors for Iteris in Stop Bar Bar Zones during Nighttime

- **False Calls:** During nighttime, false calls increased for all stop bar zones together from 3.9% in Setup 1 to 6.2% in Setup 2. This change was due to small (but significant) increases in false calls in Zones 2 and 3 that were mainly caused by headlight reflection from vehicles approaching in the lane to the left from the zone. Thus, a vehicle approaching Zone 1 could have placed a false call in Zone 2, and a vehicle approaching Zone 2 could have placed a false call in Zone 3. It is possible that the small modifications in the zones could have triggered the relatively small increase (~3%) in false calls, since it only takes a small change to move the zone over an area of increased headlight reflection.
- **Stuck-on Calls:** Similar to false calls, stuck-on calls also increased when all three stop bar zones are combined due to increases in Zones 2 and 3. It is also the case for stuck-on calls that the change in errors was relatively small, in the order of 5% or lower. The cause of these stuck-on calls could not be determined from the video images, but it is possible to be associated with the small change in the exact location of the stop bar zones.
- **Missed Calls:** Only one missed call was observed in Setup 1 during nighttime at the stop bar zones compared to none in Setup 2. This variation was not significant and did not show any change from Setup 1 to Setup 2 during nighttime in terms of missed calls.
- **Dropped Calls:** No dropped calls were found at the stop bar zones during nighttime in Setup 1 or Setup 2.

- **Overall Effects in Stop Bar Zones:** A relatively small increase in false calls (from 3.9% to 6.2%) and stuck-on calls (0.2% to 2.5%) was observed for the three stop bar zones combined during nighttime. No changes were observed in terms of missed calls or dropped calls, with 0% missed and dropped calls in Setup 2 and only one missed call in Setup 1.

5.3.3.2. Advance Zones

Detection Zones		False Calls		Stuck-on Calls		Missed Calls		Dropped Calls	
		Setup 1	Setup 2	Setup 1	Setup 2	Setup 1	Setup 2	Setup 1	Setup 2
Average of Advance Zones	Number of Calls	775	1708	775	1708	717	1623	717	1623
	Percentage Error	10.8%	5.3%	0.0%	0.0%	0.3%	0.1%	0.0%	0.0%
	Z value, Result	4.43 Decreased		0.00 , not signific.		0.72 , not signific.		0.00 , not signific.	
Zone 4	Number of Calls	175	424	175	424	159	348	159	348
	Percentage Error	8.6%	16.3%	0.0%	0.0%	0.0%	0.0%	0.0%	0.0%
	Z value, Result	-2.77 Increased		0.00 , not signific.		0.00 , not signific.		0.00 , not signific.	
Zone 5	Number of Calls	339	751	339	751	295	686	295	686
	Percentage Error	18.3%	2.7%	0.0%	0.0%	0.7%	0.1%	0.0%	0.0%
	Z value, Result	7.16 Decreased		0.00 , not signific.		1.06 , not signific.		0.00 , not signific.	
Zone 6	Number of Calls	261	533	261	533	263	589	263	589
	Percentage Error	2.7%	0.4%	0.0%	0.0%	0.0%	0.2%	0.0%	0.0%
	Z value, Result	2.23 Decreased		0.00 , not signific.		-1.00 , not signific.		0.00 , not signific.	

* The percentage of false and stuck-on calls is based on the number of calls placed by the VD system
 * The percentage of missed and dropped calls is based on the number of calls placed by the loops

Table 5.14. Errors for Iteris in Advance Zones during Nighttime

- **False Calls:** An overall decrease in false calls was observed for all advance zones combined, changing from 10.8% in Setup 1 to 5.3% in Setup 2. At the individual zone level, a significant decrease in false calls occurred in Zones 5 and 6, from 18.3% to 2.7% and from 2.7% to 0.4% respectively, while a significant increase was observed in Zone 4, from 8.6% to 16.3%.

Manual verification of the false calls showed that vehicles in the adjacent lane placed more than 90% of the calls in Zone 4 and were the cause of their increase in Setup 2 respect to Setup 1. On an opposite situation, vehicles traveling on the right-thru lane (adjacent to Zone 5) did not place as many false calls in Setup 2 compared to Setup 1, and also less flickering calls were observed in Setup 2 in Zones 5 and 6. No clear reason for changes from Setup 1 to Setup 2 was found from the videos except different combination of vehicles or travel patterns that could have affected the results.

- **Stuck-on Calls:** No stuck-on calls were found at the advance zones during nighttime in Setup 1 or Setup 2.
- **Missed Calls:** Only one missed call was observed in Zone 5 and one in Zone 6 in Setup 2 compared to 2 missed calls in Zone 5 in Setup 1. These errors did not represent any trend and the advance zones remained similar in terms of missed calls from Setup 1 to Setup 2.
- **Dropped Calls:** No dropped calls were found at the advance zones during nighttime in Setup 1 or Setup 2.
- **Overall Effects in Advance Zones:** For all advance zones combined, differences between Setup 1 and Setup 2 were limited to a decrease in false calls, from 10.8% to 5.3%. Two missed calls were observed in each setup, and no stuck-on calls or dropped calls were observed. Since no modifications were made to the advance zones between the two setups, no differences in any of the errors were expected. A possible explanation to the decrease in false calls could be related to slight differences in travel pattern or traffic composition that affected slightly the performance of the advance zones in nighttime.

5.3.4 Operational Effects of Dual Left Turn Lanes in False Calls

As mentioned in Chapter 3, the instrumented approach of the intersection under study has one shared right-thru lane and two left turn lanes. The fact that the detection zones in the left turn lanes would call the same left turn phase may mask some of the errors of VD system if the detection in the two lanes is “tied” together. For this particular condition, the false calls that are placed on the left-most lane by vehicles traveling in the center lane (both are left turn lanes) may not have practically any effect in the efficiency of the operation if the two lanes call the same signal phase. It is clear that this consideration only applies to false calls, since missed, dropped, and stuck-on calls will affect performance of the signal regardless of the phasing.

Zone		False Calls not Placed by Vehicles in Adjacent Lane			
		Daytime		Nighttime	
		Setup 1	Setup 2	Setup 1	Setup 2
Zone 1	Calls (Total number)	243	663	182	383
	False Calls (%)	0.0%	0.5%	0.0%	0.0%
	Z value, Result	-1.73 , not signif.		0.00 , not signif.	
Zone 4	Calls (Total number)	236	850	175	424
	False Calls (%)	0.0%	2.1%	0.0%	0.9%
	Z value, Result	-4.29 , increased		-2.01 , increased	

* The percentage of false calls is based on the number of calls placed by the VD system

Table 5.15. Iteris False Calls not Caused by Adjacent Vehicles

If such false calls (in Zones 1 and 4 caused by vehicles in center lane) are removed from the analysis (see Table 5.15), then the false calls in Zones 1 and 4 would be very low compared to those including all types of false calls (See false calls in Tables 5.11, 5.12, 5.13, 5.14). Thus, removing calls from adjacent vehicles, in Setup 1, no false calls are observed in Zones 1 or 4, indicating that the detection performance was ideal and all false calls would have no practical operational effects. In Setup 2, however, some false calls would be observed in both Zones 1 and 4, but in the order of 2% or less. Some causes for these false calls include pedestrians who activated the zone (both Zones 1 and 4), short cloudy-sun-cloudy variations that created a sudden contrast change (Zone 4 only), and multiple calls placed by the same vehicle (flickering) (Zone 4 only).

CHAPTER 6 FINDINGS AND CONCLUSIONS

In this report, the test setup and methodology used for a side-by-side comparison of three video detection systems at a signalized intersection is presented. In addition, it describes the effects of the changes manufacturers/vendors made to the systems in order to improve the overall performance of the initial system configuration.

The evaluation of the performance of VD systems required the collection of two types of data: 1) activation and deactivation times of each detection zone to automate detection of potential errors and to analyze large datasets; and 2) video images of the intersection to serve as a ground truth in verifying the potential errors. The two types of data were essential for efficient processing of large data.

The computer code used to process the times of activation and deactivation of the zones was calibrated and validated since the zones from the three systems were not identical in shape, size and location. The calibration and validation efforts were successful and produced the same expected errors as the manual watching of the video did.

To have the “best” possible VD configuration for the instrumented intersection, the manufacturers/vendors were given two opportunities to modify their detection zone configuration to improve the performance of their system. This allowed for an evaluation of the results before and after these configuration improvements were made.

Since the modifications to the initial VD configuration were a decision the manufacturers/vendors made based on preliminary results, the actual changes varied from one system to the other. The following is a summary of the effects the modifications had on each of the three systems:

- Peek: Changes in Peek included: 1) zooming in the camera, 2) update of the video processing card, 3) extending the front zones over the stop bar, mainly to prevent dropped calls at night, 4) overlapping stop bar zones located on the same lane, and 5) making advance zones thinner and longer.

These modifications significantly impacted the performance of the VD system. Overall, during daytime the false calls at stop bar zones increased after the modifications (from 3.7% to 7.1%) and the dropped calls were completely eliminated. Similarly, in the advance zones the false calls increased (from 1% to 6.1%), but the missed calls decreased (from 37.5% to 14.3%).

During nighttime, the false calls at stop bar zones increased (from 2% to 8.5%) and so did the missed calls (from 1% to 7.3%), but dropped calls were completely eliminated (from 11.4% in Setup 1). At the advance zones the false calls increased (from 1.5% to 3.3%) and missed calls decreased (from 12.3% to 1.9%).

Results showed that changes in the stop bar zones effectively reduced dropped calls during daytime, as it was intended by extending the zones and overlapping the ones on the same lane. However, at the same time changes increased false calls mainly due to turning vehicles. At night, dropped calls were completely eliminated, but at the expense of increasing missed and false calls.

These changes indicate that an improvement on the main target error (dropped calls) at the stop bar zones was achieved, but some compromise was made by increasing the detection area, thereby increasing false calls.

In the advance zones, in both daytime and nighttime, there was a clear tradeoff between decreasing missed calls (a concern in the initial configuration) and increasing false calls. As the detection zones are more easily activated, reducing the chances of missing vehicles, adjacent vehicles or headlight reflection will also more easily activate the zone, creating false calls.

- Autoscope: Changes to Autoscope's initial configuration included: 1) changing stop bar zones to Type 9 detectors, 2) lowering detector refresh time to 90 seconds, 3) changing advance zones to count zones, and 4) repositioning and relocation of detection zones.

These changes had very limited effects on the performance of the stop bar zones in daytime, increasing stuck-on calls (from 0.2% to 0.8%) and missed calls by less than 1%; greater effects were observed during nighttime false calls, with an increase from 19% to 29.5%, mostly due to the headlight reflection of turning vehicles from the center lane. On the other hand, missed calls in the stop bar zones during nighttime decreased from 0.6% (4 missed vehicles) to 0%.

Regarding the advance zones, a decrease was observed in false calls (from 10.9% to 2.3%) and missed calls (from 11.6% to 3.8%) in daytime; during nighttime, false calls increased from 19.9% to 25.8% and missed calls decreased (from 5.7% to 0.1%).

Overall, changes did not provide a clear improvement of performance at stop bar zones, but significantly improved advance zones by reducing missed calls in both day and night (despite the increase in false calls during nighttime).

- Iteris: Changes in Iteris were limited to slight modifications in the size of the stop bar zones. Overall effects of these changes were relatively small (<3%) for the three stop bar zones combined or the three advance zones combined in both daytime and nighttime, except for a slightly more significant reduction of 5.5% in the nighttime false calls.

It is noted that at the individual zone level, Zone 4 increased false calls (6.2% in daytime, and 7.7% in nighttime) while Zone 5 decreased them (3.6% in daytime and 15.6% in nighttime). Also, a tradeoff between false and missed calls was observed within Zones 4 and 5. Zone 4 increased false calls but decreased missed calls, and Zone 5 decreased false calls but it also increased missed calls.

Modifications to the initial configuration of the VD systems improved performance in terms of the most prominent errors at the time (missed and dropped calls); however, that was at the expense of making a compromise and increasing other type of errors, in this case false calls.

These results indicate that tradeoffs may exist when the goal is to improve the overall performance of VD systems. Field engineers should be aware of these tradeoffs and consider the possibility of generating additional errors of equal or greater impact in the VD detection performance while trying to fix known issues. Thus, after making modifications to the configuration of VD systems, the effects of these changes should be monitored not only for improvements on the previously detected errors, but also for potential new errors of a different type.

REFERENCES

1. Chitturi, M., J. C. Medina, and R. F Benekohal, Accuracy of Video Detection Systems for Traffic Counting. Proceedings of the 2007 ITE International Annual Meeting and Exhibit, August 5 - 8, 2007.
2. Grenard, J., D. Bullock, and A. Tarko, Evaluation of Selected Video Detection Systems at Signalized Intersections. Publication Rep. FHWA/IN/JTRP-2001/22. Purdue University, West Lafayette, IN, 2001.
3. MacCarley, A., City of Anaheim/Caltrans/FHWA Advanced Traffic Control System Field Operational Test Evaluation: Task C Video Traffic Detection System. California Polytechnic State University, San Luis Obispo, CA, 1998.
4. MnDOT and SRF Consulting Group Inc., Evaluation of Non-intrusive Technologies for Traffic Detection. Evaluation Test Plan. Vol. 1, Minneapolis, MN, 2001.
5. Rhodes, A., E. J. Smaglik, and D. Bullock, Vendor Comparison of Video Detection Systems. Publication Rep. FHWA/IN/JTRP-2005/30. Purdue University, West Lafayette, 2006.
6. Rhodes, A., E. J. Smaglik, D. Bullock, and J. Sturdevant, Operational Performance Comparison of Video Detection Systems. Proceedings of the 2007 ITE International Annual Meeting and Exhibit, August 5 - 8, 2007.
7. Rhodes, A., K. Jennings, and D. Bullock, Consistencies of Video Detection Activation and De-activation Times Between Day and Night Periods, *ASCE Journal of Transportation Engineering*, Vol. 133, No. 9, 2007, pp. 505-512.

APPENDIX A - CALIBRATION OF ALGORITHM PARAMETERS FOR INITIAL SETUP

In Chapter 4, the Performance Measures (PMs) employed in this study were explained and the data reduction procedure was discussed. It should be recalled that the first stage of quantifying PMs was called the Preliminary stage, and a SAS program was used to automate the analysis and accomplish this task. In section 4.2.5 of this report, calibration of the algorithm parameters (used in the SAS program) was discussed. Three datasets (two at noon time and one at night), each one hour long were used for the calibration. In that Section, however, the effect of calibration was depicted only for Zones 1 and 4 of a noon dataset. In this appendix the results of the calibration procedure for all the three datasets and all the zones is presented.

ZONE 1												
False calls			Missed Calls			Stuck-on calls			Dropped calls			
Computed	Expected	Actual	Computed	Expected	Actual	Computed	Expected	Actual	Computed	Expected	Actual	
Autoscope	4	4	5	0	0	0	0	0	0	0	0	
Peek	5	5	5	0	0	0	0	0	0	0	0	
Iteris	24	24	24	0	0	0	0	0	0	0	0	
ZONE 2												
Autoscope	0	0	0	0	0	0	0	0	0	0	0	
Peek	0	0	0	2	2	4	0	0	0	1	1	
Iteris	3	3	3	0	0	0	0	0	0	0	0	
ZONE 3												
Autoscope	0	0	0	0	0	0	0	0	0	0	0	
Peek	0	0	0	4	4	4	0	0	0	0	0	
Iteris	0	0	0	0	0	0	0	0	0	0	0	
ZONE 4												
Autoscope	74	74	74	18	18	18	0	0	0	0	0	
Peek	0	0	0	26	26	26	0	0	0	0	0	
Iteris	14	14	14	1	1	1	0	0	0	0	0	
ZONE 5												
Autoscope	0	0	0	9	9	9	0	0	0	0	0	
Peek	0	0	0	36	36	36	0	0	0	0	0	
Iteris	13	13	13	1	1	1	0	0	0	0	0	
ZONE 6												
Autoscope	0	0	0	2	2	2	0	0	0	0	0	
Peek	0	0	0	31	31	31	1	1	0	0	0	
Iteris	1	1	1	0	0	0	0	0	0	0	0	

August 11, 2005 Noon Data

ZONE 1

	False calls			Missed Calls			Stuck-on calls			Dropped calls		
	Computed	Expected	Actual	Computed	Expected	Actual	Computed	Expected	Actual	Computed	Expected	Actual
Autoscope	5	5	5	0	0	0	0	0	0	0	0	0
Peek	7	7	7	0	0	0	0	0	0	0	0	0
Iteris	19	19	19	0	0	0	0	0	0	0	0	0

ZONE 2

Autoscope	2	2	2	0	0	0	0	0	0	0	0	0
Peek	2	2	0	0	0	0	0	0	0	0	0	0
Iteris	3	3	3	0	0	0	0	0	0	0	0	0

ZONE 3

Autoscope	2	2	2	0	0	0	0	0	0	0	0	0
Peek	0	0	0	1	1	1	0	0	0	2	2	2
Iteris	1	1	1	0	0	0	0	0	0	0	0	0

ZONE 4

Autoscope	2	2	2	14	14	15	0	0	0	0	0	0
Peek	0	0	0	25	25	25	0	0	0	0	0	0
Iteris	10	10	10	0	0	0	1	1	1	0	0	0

ZONE 5

Autoscope	2	2	2	6	6	6	1	1	0	0		0
Peek	0	0	0	46	46	46	2	2	0	0		0
Iteris	6	6	6	1	1	1	0	0	0	0		0

ZONE 6

Autoscope	0		1	0	0	0	1	1	1	0	0	0
Peek	2	2	0	27	27	27	0	0	0	0	0	0
Iteris	0		0	0	0	0	0	0	0	0	0	0

August 10, 2005 Noon Data

ZONE 1

	False calls			Missed Calls			Stuck-on calls			Dropped calls		
	Computed	Expected	Actual	Computed	Expected	Actual	Computed	Expected	Actual	Computed	Expected	Actual
Autoscope	0	0	0	1	1	1	0	0	0	0	0	0
Peek	2	2	2	2	2	2	0	0	0	5	5	5
Iteris	0	0	0	0	0	0	0	0	0	0	0	0

ZONE 2

Autoscope	19	19	19	0	0	0	0	0	0	0	0	0
Peek	2	2	2	0	0	0	0	0	0	3	3	3
Iteris	0	0	0	0	0	0	0	0	0	0	0	0

ZONE 3

Autoscope	6	6	6	0	0	0	1	1	1	0	0	0
Peek	2	2	2	0	0	0	0	0	0	7	7	7
Iteris	0	0	0	0	0	0	0	0	0	0	0	0

ZONE 4

Autoscope	0	0	0	4	4	4	0	0	0	0	0	0
Peek	0	0	0	2	2	2	0	0	0	0	0	0
Iteris	4	4	4	0	0	0	0	0	0	0	0	0

ZONE 5

Autoscope	21	21	21	1	1	1	1	1	1	0	0	0
Peek	6	6	6	4	4	4	0	0	0	0	0	0
Iteris	14	14	14	1	1	1	0	0	0	0	0	0

ZONE 6

Autoscope	9	9	9	0	0	0	0	0	0	0	0	0
Peek	0	0	0	15	15	16	0	0	0	0	0	0
Iteris	0	0	0	0	0	0	0	0	0	0	0	0

August 9, 2005 Night Data

Description of differences between computed and actual calls from the tables above (highlighted in yellow) are provided below for illustration purposes:

CASE 1 (Data Set 1, Zone 1, False Calls, Autoscope)

All the five false calls were due to truck sideswipe. At 12:59:29 a truck generated a false call, but before the false call was dropped a vehicle came in lane 1 and activated the loop in zone 1, thus the program did not pick it up as false call.

CASE 2 (Data Set 1, Zone 2, Missed Calls, Peek)

At 12:32:53 and 13:24:12, second vehicle missed but passed over the loop not later than 4 seconds after the first vehicle, thus the program didn't pick it up as a missed call.

CASE 3 (Data Set 1, Zone 6, Stuck-on Calls, Peek)

At 12:38:55, Back of queue reached peek's advance zone and caused the stuck-on call on the advance zone.

CASE 4 (Data Set 2, Zone 2, False Calls, Peek)

At 12:50:15 VD dropped call and recovered. Vehicle activated loop more than 3 seconds after dropping the first call. At 12:58:23 Vehicle changed lanes from zone 3 to 1.

CASE 5 (Data Set 2, Zone 4, Missed Calls, Autoscope)

At 12:28:28 VD missed first of two vehicles. Second vehicle followed first very closely and activated the loop shortly after first vehicle and the program didn't count it as a missed call.

CASE 6 (Data Set 2, Zone 5, Stuck-on Calls, Autoscope)

Slow moving truck due to queue caused the stuck-on call.

CASE 7 (Data Set 2, Zone 5, Stuck-on Calls, Peek)

At 12:00:17 and 12:00:38, back of queue reached the advance zone, generating the two stuck-on calls.

CASE 8 (Data Set 2, Zone 6, False Calls, Peek)

At 12:09:28 and 12:52:18, slow vehicles passed over the advance zone about 3 seconds after the loop call, thus the program picked the advance zones calls as false calls.

CASE 9 (Data Set 3, Zone 6, Missed Calls, Peek)

At 21:44:21 VD missed first of two vehicles. Second vehicle followed first very closely and activated the loop shortly after first vehicle and the program didn't count it as a missed call.

APPENDIX B - DAILY VARIATION OF VIDEO DETECTION PERFORMANCE

As explained in Chapter 5, eight datasets from Setup 1 (4 for Sunny Noon and 4 for Night) and ten datasets from Setup 2 (5 for Sunny Noon and 5 for Night) were used to evaluate the VD performance in the initial and “best” configuration. Each dataset is about 1 hour long for Setup 1, and about 2 hours long for Setup 2, and represents the operation for that time on that day. Also in Chapter 5, the VD performance was analyzed when the data for four days for Setup 1 and five days for Setup 2 were aggregated into one single dataset to represent each condition. In this Appendix, the VD performance is presented on a day-by-day basis, so it is possible to observe the daily variation of the performance measures for each of three the systems. To do this, tables with the actual percentage of the four types of error from each day, and in each detection zone are provided. Also, a graphical representation indicating the variation range (maximum and minimum) and the average percentage for all types of errors in all detection zones are included for an easier interpretation of the data.

Setup 1 - Daytime

False Calls

Stop Bar Zones

Advance Zones

		AUTOSCOPE	PEEK	ITERIS			AUTOSCOPE	PEEK	ITERIS
ZONE 1	DAY 1	7.5%	12.8%	26.4%	ZONE 4	DAY 1	8.7%	13.3%	25.0%
	DAY 2	9.6%	12.1%	28.4%		DAY 2	4.7%	0.0%	14.9%
	DAY 3	8.3%	8.9%	33.3%		DAY 3	70.4%	0.0%	23.7%
	DAY 4	2.3%	6.3%	11.8%		DAY 4	3.6%	3.2%	8.6%
ZONE 2	DAY 1	0.0%	0.0%	3.8%	ZONE 5	DAY 1	0.0%	0.0%	3.4%
	DAY 2	3.2%	2.9%	4.2%		DAY 2	1.9%	0.0%	5.1%
	DAY 3	0.0%	0.0%	4.3%		DAY 3	0.0%	0.0%	11.0%
	DAY 4	2.2%	1.7%	5.6%		DAY 4	9.9%	0.0%	14.7%
ZONE 3	DAY 1	0.0%	3.4%	0.0%	ZONE 6	DAY 1	0.0%	0.0%	0.0%
	DAY 2	4.0%	0.0%	1.9%		DAY 2	0.0%	4.9%	0.0%
	DAY 3	0.0%	0.0%	0.0%		DAY 3	0.0%	0.0%	1.2%
	DAY 4	0.0%	0.0%	0.0%		DAY 4	0.0%	0.0%	0.0%

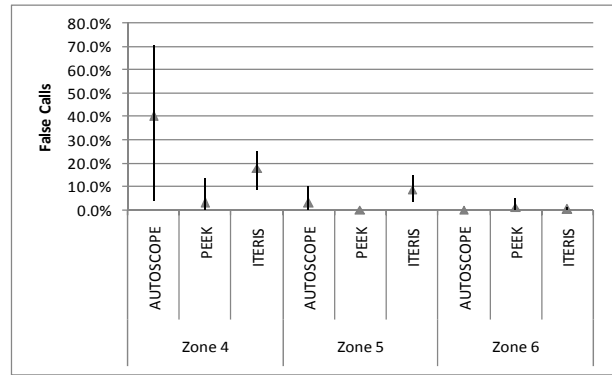
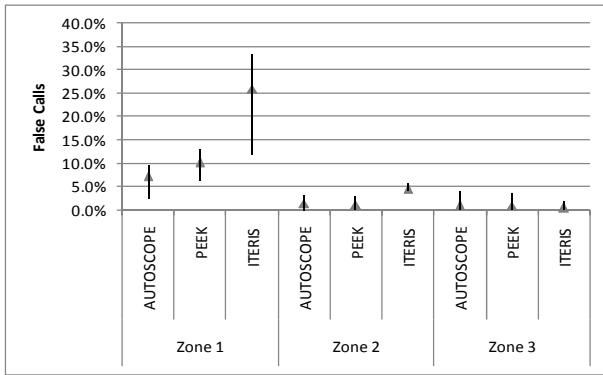

Missed Calls

Stop Bar Zones

Advance Zones

		AUTOSCOPE	PEEK	ITERIS			AUTOSCOPE	PEEK	ITERIS
ZONE 1	DAY 1	0.0%	2.2%	0.0%	ZONE 4	DAY 1	43.6%	64.1%	0.0%
	DAY 2	0.0%	0.0%	0.0%		DAY 2	23.3%	41.7%	0.0%
	DAY 3	0.0%	0.0%	0.0%		DAY 3	37.5%	54.2%	2.1%
	DAY 4	0.0%	0.0%	0.0%		DAY 4	50.9%	47.4%	3.5%
ZONE 2	DAY 1	0.0%	1.4%	0.0%	ZONE 5	DAY 1	9.7%	41.9%	2.2%
	DAY 2	0.0%	0.0%	0.0%		DAY 2	4.6%	35.4%	0.8%
	DAY 3	0.0%	2.2%	0.0%		DAY 3	7.9%	35.1%	0.9%
	DAY 4	0.0%	0.0%	0.0%		DAY 4	4.3%	27.7%	0.0%
ZONE 3	DAY 1	0.0%	6.0%	0.0%	ZONE 6	DAY 1	0.0%	32.4%	0.0%
	DAY 2	0.0%	1.6%	0.0%		DAY 2	0.0%	38.0%	0.0%
	DAY 3	0.0%	4.8%	0.0%		DAY 3	2.3%	36.0%	0.0%
	DAY 4	0.0%	0.0%	0.0%		DAY 4	0.0%	20.9%	0.0%

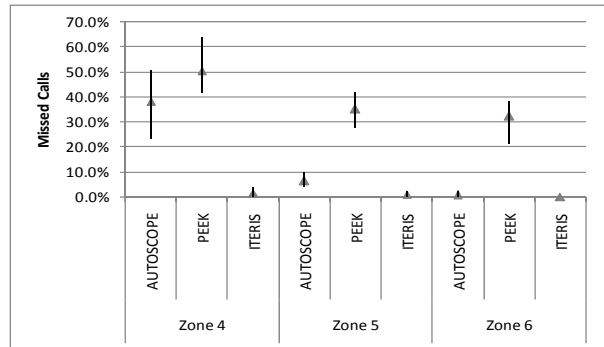
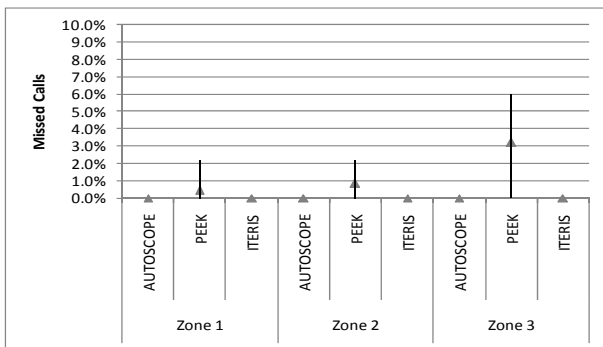

Stuck-on Calls

Stop Bar Zones					Advance Zones				
		AUTOSCOPE	PEEK	ITERIS			AUTOSCOPE	PEEK	ITERIS
ZONE 1	DAY 1	0.0%	0.0%	0.0%	ZONE 4	DAY 1	0.0%	0.0%	0.0%
	DAY 2	0.0%	0.0%	0.0%		DAY 2	0.0%	0.0%	0.0%
	DAY 3	0.0%	0.0%	0.0%		DAY 3	0.0%	0.0%	0.0%
	DAY 4	0.0%	0.0%	0.0%		DAY 4	0.0%	0.0%	0.0%
ZONE 2	DAY 1	0.0%	0.0%	0.0%	ZONE 5	DAY 1	0.0%	0.0%	0.0%
	DAY 2	0.0%	0.0%	0.0%		DAY 2	1.0%	3.3%	0.0%
	DAY 3	0.0%	0.0%	0.0%		DAY 3	0.0%	0.0%	0.0%
	DAY 4	0.0%	0.0%	0.0%		DAY 4	0.0%	0.0%	0.0%
ZONE 3	DAY 1	0.0%	0.0%	0.0%	ZONE 6	DAY 1	0.0%	0.0%	0.0%
	DAY 2	0.0%	0.0%	0.0%		DAY 2	1.5%	0.0%	0.0%
	DAY 3	0.0%	0.0%	0.0%		DAY 3	0.0%	2.0%	0.0%
	DAY 4	2.1%	0.0%	0.0%		DAY 4	0.0%	0.0%	0.0%

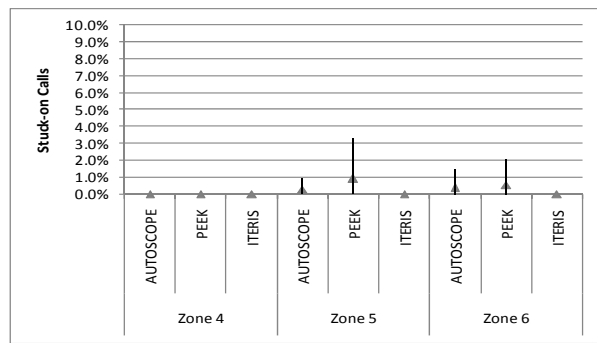
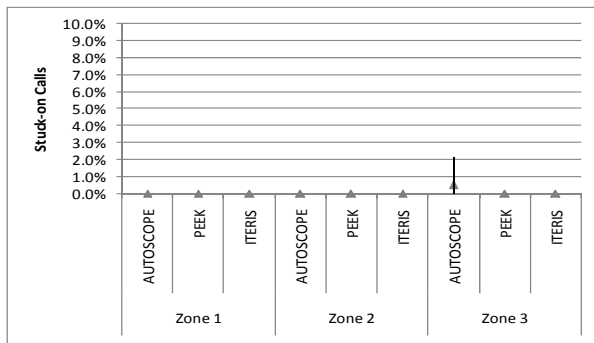

Dropped Calls

Stop Bar Zones					Advance Zones				
		AUTOSCOPE	PEEK	ITERIS			AUTOSCOPE	PEEK	ITERIS
ZONE 1	DAY 1	0.0%	0.0%	0.0%	ZONE 4	DAY 1	0.0%	0.0%	0.0%
	DAY 2	0.0%	0.0%	0.0%		DAY 2	0.0%	0.0%	0.0%
	DAY 3	0.0%	0.0%	0.0%		DAY 3	0.0%	0.0%	0.0%
	DAY 4	0.0%	0.0%	0.0%		DAY 4	0.0%	0.0%	0.0%
ZONE 2	DAY 1	0.0%	0.0%	0.0%	ZONE 5	DAY 1	0.0%	0.0%	0.0%
	DAY 2	0.0%	0.0%	0.0%		DAY 2	0.0%	0.0%	0.0%
	DAY 3	0.0%	0.0%	0.0%		DAY 3	0.0%	0.0%	0.0%
	DAY 4	0.0%	2.6%	0.0%		DAY 4	0.0%	0.0%	0.0%
ZONE 3	DAY 1	0.0%	0.0%	0.0%	ZONE 6	DAY 1	0.0%	0.0%	0.0%
	DAY 2	0.0%	3.2%	0.0%		DAY 2	0.0%	0.0%	0.0%
	DAY 3	0.0%	0.0%	0.0%		DAY 3	0.0%	0.0%	0.0%
	DAY 4	0.0%	0.0%	0.0%		DAY 4	0.0%	0.0%	0.0%

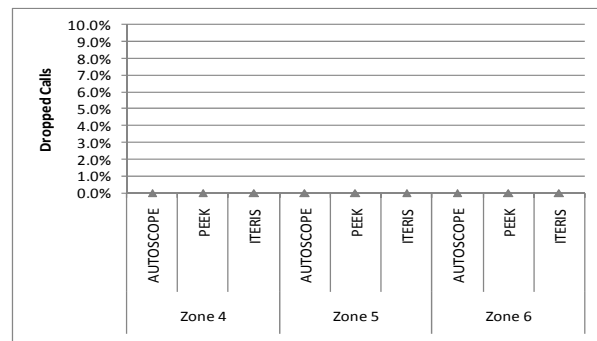
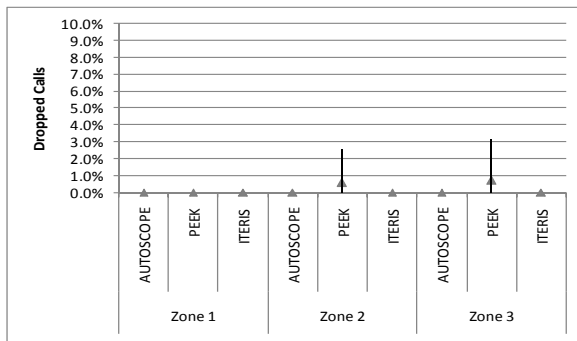

Setup 1 - Nighttime

False Calls

Stop Bar Zones

Advance Zones

		AUTOSCOPE	PEEK	ITERIS			AUTOSCOPE	PEEK	ITERIS
ZONE 1	DAY 1	2.0%	1.6%	9.1%	ZONE 4	DAY 1	0.0%	0.0%	6.7%
	DAY 2	0.0%	0.0%	12.5%		DAY 2	0.0%	0.0%	8.3%
	DAY 3	0.0%	5.9%	0.0%		DAY 3	0.0%	0.0%	12.1%
	DAY 4	4.4%	1.8%	16.1%		DAY 4	0.0%	0.0%	8.7%
ZONE 2	DAY 1	36.6%	2.6%	3.3%	ZONE 5	DAY 1	35.2%	1.5%	20.4%
	DAY 2	21.9%	2.7%	4.2%		DAY 2	20.0%	0.0%	11.8%
	DAY 3	34.5%	4.3%	0.0%		DAY 3	30.0%	11.8%	22.2%
	DAY 4	37.0%	2.8%	0.0%		DAY 4	32.4%	0.0%	20.0%
ZONE 3	DAY 1	16.4%	0.0%	0.0%	ZONE 6	DAY 1	15.8%	0.0%	4.2%
	DAY 2	14.8%	1.4%	0.0%		DAY 2	15.7%	3.8%	2.9%
	DAY 3	10.9%	3.1%	0.0%		DAY 3	13.6%	0.0%	0.0%
	DAY 4	11.9%	0.0%	0.0%		DAY 4	15.0%	0.0%	3.4%

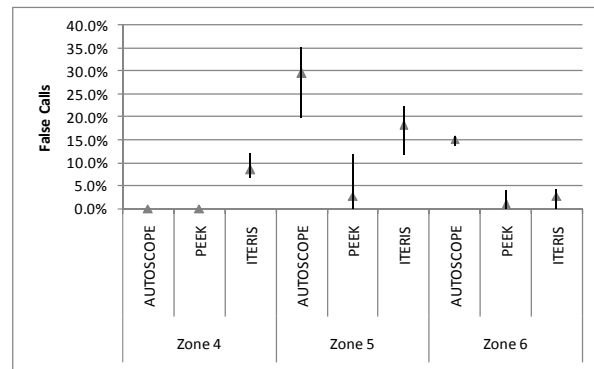
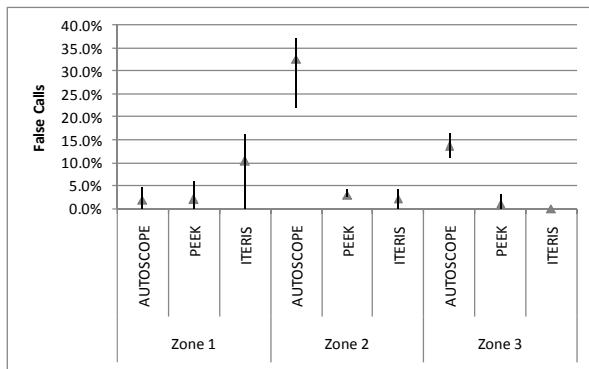

Missed Calls

Stop Bar Zones

Advance Zones

		AUTOSCOPE	PEEK	ITERIS			AUTOSCOPE	PEEK	ITERIS
ZONE 1	DAY 1	0.0%	0.0%	0.0%	ZONE 4	DAY 1	23.2%	16.1%	0.0%
	DAY 2	0.0%	0.0%	0.0%		DAY 2	30.3%	15.2%	0.0%
	DAY 3	3.0%	6.1%	0.0%		DAY 3	14.3%	7.1%	0.0%
	DAY 4	2.1%	2.1%	0.0%		DAY 4	26.2%	11.9%	0.0%
ZONE 2	DAY 1	0.0%	0.0%	0.0%	ZONE 5	DAY 1	2.5%	8.9%	1.3%
	DAY 2	0.0%	2.7%	1.4%		DAY 2	0.0%	4.7%	0.0%
	DAY 3	0.0%	0.0%	0.0%		DAY 3	1.8%	7.3%	1.8%
	DAY 4	0.0%	0.0%	0.0%		DAY 4	0.0%	5.3%	0.0%
ZONE 3	DAY 1	0.0%	0.0%	0.0%	ZONE 6	DAY 1	0.0%	14.5%	0.0%
	DAY 2	2.8%	1.4%	0.0%		DAY 2	0.0%	21.4%	0.0%
	DAY 3	0.0%	0.0%	0.0%		DAY 3	0.0%	22.4%	0.0%
	DAY 4	0.0%	1.8%	0.0%		DAY 4	0.0%	14.0%	0.0%

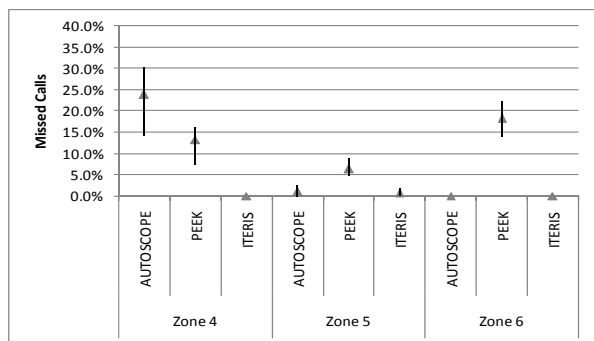
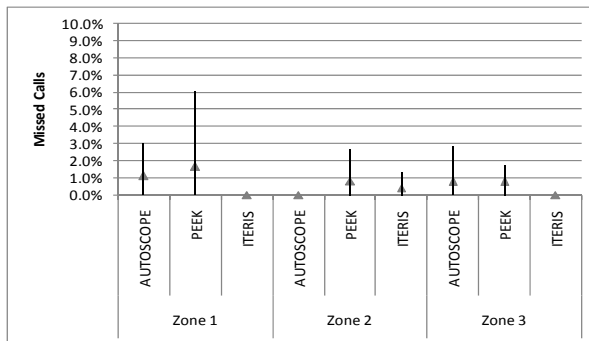

Stuck-on Calls

Stop Bar Zones

		AUTOSCOPE	PEEK	ITERIS
ZONE 1	DAY 1	2.0%	0.0%	0.0%
	DAY 2	0.0%	0.0%	0.0%
	DAY 3	0.0%	0.0%	0.0%
	DAY 4	0.0%	0.0%	0.0%
ZONE 2	DAY 1	1.2%	0.0%	1.7%
	DAY 2	1.4%	0.0%	0.0%
	DAY 3	0.0%	0.0%	0.0%
	DAY 4	0.0%	0.0%	0.0%
ZONE 3	DAY 1	0.0%	0.0%	0.0%
	DAY 2	0.0%	0.0%	0.0%
	DAY 3	1.8%	0.0%	0.0%
	DAY 4	0.0%	0.0%	0.0%

Advance Zones

		AUTOSCOPE	PEEK	ITERIS
ZONE 4	DAY 1	0.0%	0.0%	0.0%
	DAY 2	0.0%	0.0%	0.0%
	DAY 3	0.0%	0.0%	0.0%
	DAY 4	0.0%	0.0%	0.0%
ZONE 5	DAY 1	0.0%	0.0%	0.0%
	DAY 2	0.0%	0.0%	0.0%
	DAY 3	1.4%	0.0%	0.0%
	DAY 4	0.0%	0.0%	0.0%
ZONE 6	DAY 1	0.0%	0.0%	0.0%
	DAY 2	0.0%	0.0%	0.0%
	DAY 3	0.0%	0.0%	0.0%
	DAY 4	0.0%	0.0%	0.0%

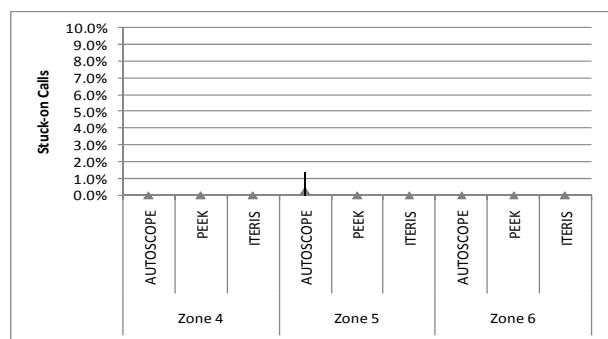
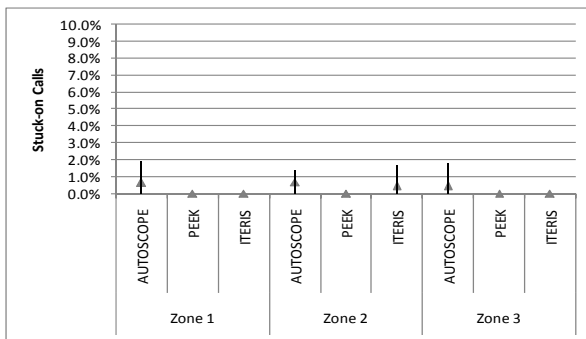

Dropped Calls

Stop Bar Zones

		AUTOSCOPE	PEEK	ITERIS
ZONE 1	DAY 1	0.0%	8.2%	0.0%
	DAY 2	0.0%	13.5%	0.0%
	DAY 3	0.0%	15.2%	0.0%
	DAY 4	0.0%	8.3%	0.0%
ZONE 2	DAY 1	0.0%	13.8%	0.0%
	DAY 2	0.0%	8.1%	0.0%
	DAY 3	0.0%	6.5%	0.0%
	DAY 4	0.0%	6.3%	0.0%
ZONE 3	DAY 1	0.0%	19.0%	0.0%
	DAY 2	0.0%	12.7%	0.0%
	DAY 3	0.0%	10.9%	0.0%
	DAY 4	0.0%	15.8%	0.0%

Advance Zones

		AUTOSCOPE	PEEK	ITERIS
ZONE 4	DAY 1	0.0%	0.0%	0.0%
	DAY 2	0.0%	0.0%	0.0%
	DAY 3	0.0%	0.0%	0.0%
	DAY 4	0.0%	0.0%	0.0%
ZONE 5	DAY 1	0.0%	0.0%	0.0%
	DAY 2	0.0%	0.0%	0.0%
	DAY 3	0.0%	0.0%	0.0%
	DAY 4	0.0%	0.0%	0.0%
ZONE 6	DAY 1	0.0%	0.0%	0.0%
	DAY 2	0.0%	0.0%	0.0%
	DAY 3	0.0%	0.0%	0.0%
	DAY 4	0.0%	0.0%	0.0%

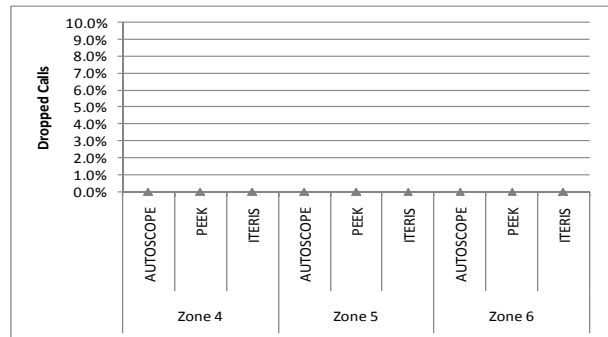
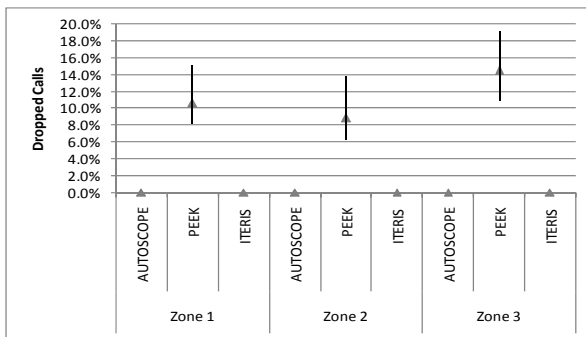

Setup 2 – Daytime

False Calls

Stop Bar Zones

Advance Zones

Zone	Day	Stop Bar Zones			Advance Zones				
		AUTOSCOPE	PEEK	ITERIS	AUTOSCOPE	PEEK	ITERIS		
ZONE 1	DAY 1	1.8%	11.6%	14.0%	ZONE 4	DAY 1	1.0%	14.6%	15.9%
	DAY 2	6.7%	23.5%	19.4%		DAY 2	3.3%	15.9%	12.9%
	DAY 3	5.2%	23.6%	23.1%		DAY 3	3.3%	15.9%	24.3%
	DAY 4	9.3%	22.7%	21.8%		DAY 4	9.9%	18.6%	28.8%
	DAY 5	4.5%	11.7%	19.1%		DAY 5	3.9%	17.6%	28.1%
ZONE 2	DAY 1	0.8%	0.7%	0.8%	ZONE 5	DAY 1	0.0%	0.0%	2.8%
	DAY 2	0.0%	1.9%	1.9%		DAY 2	0.0%	0.0%	1.6%
	DAY 3	6.5%	10.4%	14.6%		DAY 3	6.2%	10.4%	13.4%
	DAY 4	1.7%	1.4%	8.6%		DAY 4	2.5%	0.7%	2.5%
	DAY 5	0.0%	1.3%	2.0%		DAY 5	0.9%	0.6%	4.3%
ZONE 3	DAY 1	0.0%	0.0%	0.0%	ZONE 6	DAY 1	0.8%	0.0%	3.2%
	DAY 2	0.0%	0.0%	1.1%		DAY 2	0.0%	0.0%	0.0%
	DAY 3	0.0%	0.0%	0.9%		DAY 3	1.4%	0.0%	0.7%
	DAY 4	0.0%	0.0%	0.0%		DAY 4	5.3%	0.0%	1.7%
	DAY 5	0.0%	0.0%	0.0%		DAY 5	0.0%	0.0%	0.6%

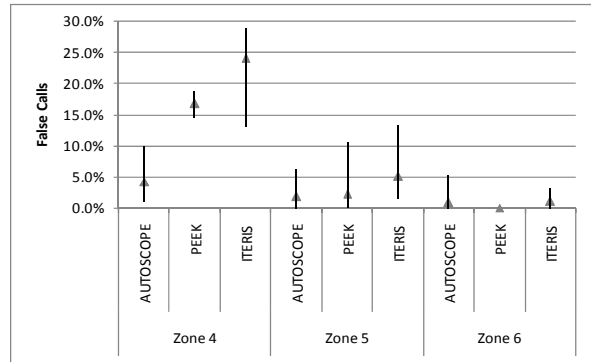
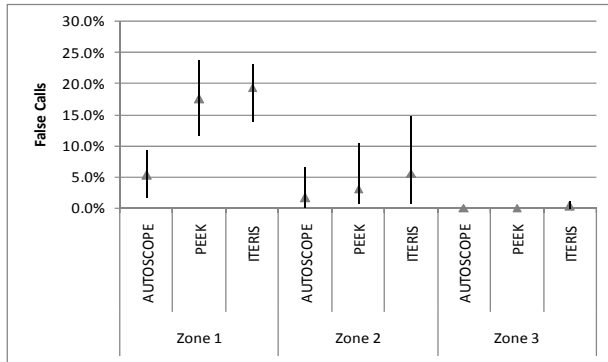

Missed Calls

Stop Bar Zones

Advance Zones

Zone	Day	Stop Bar Zones			Advance Zones				
		AUTOSCOPE	PEEK	ITERIS	AUTOSCOPE	PEEK	ITERIS		
ZONE 1	DAY 1	0.7%	0.0%	0.0%	ZONE 4	DAY 1	17.2%	12.3%	0.0%
	DAY 2	2.4%	1.2%	0.0%		DAY 2	10.7%	14.7%	0.0%
	DAY 3	0.0%	0.9%	0.0%		DAY 3	12.0%	13.0%	0.0%
	DAY 4	0.9%	0.9%	0.0%		DAY 4	11.8%	17.3%	0.0%
	DAY 5	0.8%	0.0%	0.0%		DAY 5	4.5%	15.4%	0.0%
ZONE 2	DAY 1	0.0%	0.6%	0.0%	ZONE 5	DAY 1	3.0%	3.0%	5.4%
	DAY 2	1.6%	1.6%	0.8%		DAY 2	1.4%	3.5%	3.5%
	DAY 3	0.7%	0.7%	0.0%		DAY 3	4.0%	10.9%	8.0%
	DAY 4	0.0%	0.0%	0.0%		DAY 4	1.7%	8.9%	5.6%
	DAY 5	0.0%	1.0%	0.0%		DAY 5	0.4%	8.1%	5.5%
ZONE 3	DAY 1	0.0%	0.8%	0.0%	ZONE 6	DAY 1	0.0%	0.0%	0.0%
	DAY 2	0.0%	1.9%	0.0%		DAY 2	0.0%	0.7%	0.7%
	DAY 3	0.0%	5.6%	0.7%		DAY 3	0.0%	1.3%	0.0%
	DAY 4	0.0%	1.8%	0.0%		DAY 4	0.0%	17.8%	0.0%
	DAY 5	0.0%	1.2%	0.0%		DAY 5	0.0%	0.6%	0.0%

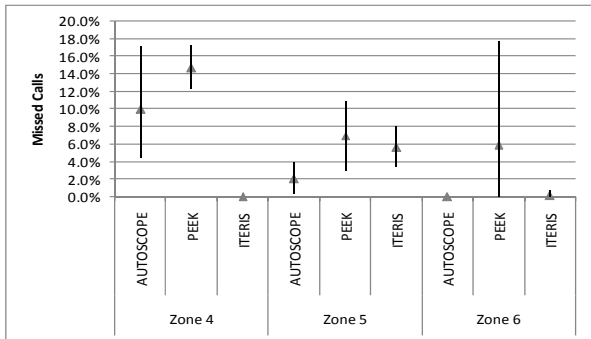
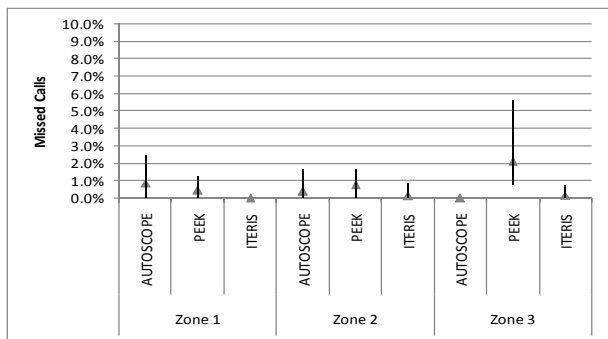

Stuck-on Calls

Stop Bar Zones

Advance Zones

		AUTOSCOPE	PEEK	ITERIS			AUTOSCOPE	PEEK	ITERIS
ZONE 1	DAY 1	2.7%	0.0%	0.0%	ZONE 4	DAY 1	1.0%	0.0%	0.0%
	DAY 2	0.0%	0.0%	0.0%		DAY 2	0.0%	0.0%	0.0%
	DAY 3	1.0%	0.0%	0.0%		DAY 3	2.2%	0.0%	0.0%
	DAY 4	0.0%	0.0%	0.0%		DAY 4	0.0%	0.0%	0.0%
	DAY 5	4.5%	0.0%	0.0%		DAY 5	0.0%	0.9%	0.0%
ZONE 2	DAY 1	0.0%	0.0%	0.0%	ZONE 5	DAY 1	2.2%	0.0%	0.0%
	DAY 2	0.0%	0.0%	0.0%		DAY 2	0.0%	0.0%	0.0%
	DAY 3	1.9%	0.0%	0.0%		DAY 3	0.6%	0.0%	0.0%
	DAY 4	0.0%	0.0%	0.0%		DAY 4	0.0%	0.7%	0.0%
	DAY 5	0.0%	0.0%	0.0%		DAY 5	0.0%	0.0%	0.0%
ZONE 3	DAY 1	1.0%	0.0%	0.0%	ZONE 6	DAY 1	0.0%	0.0%	0.0%
	DAY 2	0.0%	0.0%	0.0%		DAY 2	0.0%	0.0%	0.0%
	DAY 3	0.0%	0.0%	0.0%		DAY 3	0.0%	0.8%	0.0%
	DAY 4	0.0%	0.0%	0.0%		DAY 4	0.0%	0.0%	0.0%
	DAY 5	0.0%	0.0%	0.0%		DAY 5	0.0%	0.0%	0.0%

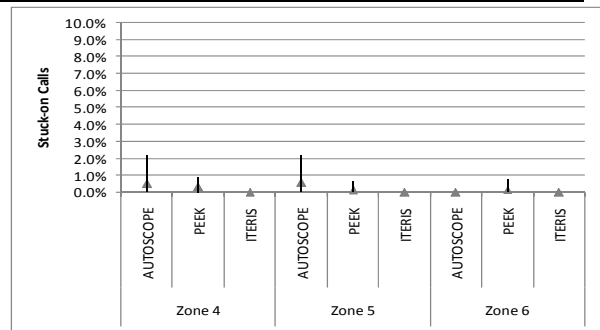
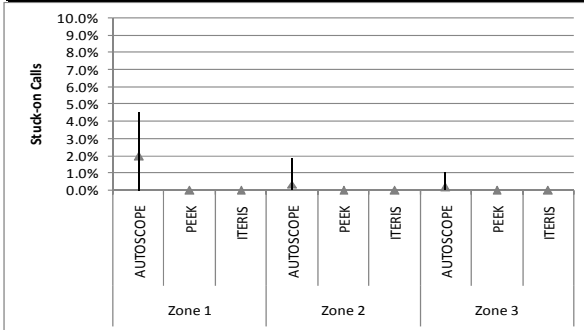

Setup 2 – Nighttime

False Calls

Stop Bar Zones

Advance Zones

Zone	Day	Stop Bar Zones			Advance Zones				
		AUTOSCOPE	PEEK	ITERIS	AUTOSCOPE	PEEK	ITERIS		
ZONE 1	DAY 1	4.5%	14.1%	15.7%	ZONE 4	DAY 1	0.0%	13.6%	23.2%
	DAY 2	4.3%	2.1%	2.9%		DAY 2	0.0%	8.9%	17.2%
	DAY 3	11.9%	10.0%	11.9%		DAY 3	0.0%	12.5%	16.1%
	DAY 4	12.5%	12.5%	18.7%		DAY 4	1.8%	8.6%	15.5%
	DAY 5	10.9%	4.0%	8.5%		DAY 5	1.7%	15.8%	13.4%
ZONE 2	DAY 1	23.5%	8.7%	1.2%	ZONE 5	DAY 1	14.3%	0.0%	0.8%
	DAY 2	35.3%	19.4%	4.1%		DAY 2	21.6%	0.0%	5.8%
	DAY 3	31.1%	12.7%	3.3%		DAY 3	17.9%	0.0%	1.7%
	DAY 4	28.6%	7.0%	3.5%		DAY 4	13.6%	0.0%	2.5%
	DAY 5	46.7%	18.4%	12.5%		DAY 5	20.7%	0.0%	2.1%
ZONE 3	DAY 1	33.0%	0.0%	0.0%	ZONE 6	DAY 1	43.1%	1.3%	0.0%
	DAY 2	29.9%	0.0%	1.9%		DAY 2	46.0%	0.0%	0.9%
	DAY 3	34.4%	1.4%	3.4%		DAY 3	43.0%	0.0%	1.0%
	DAY 4	37.4%	0.0%	2.6%		DAY 4	42.7%	0.0%	0.0%
	DAY 5	36.8%	1.1%	7.1%		DAY 5	29.5%	0.0%	0.0%

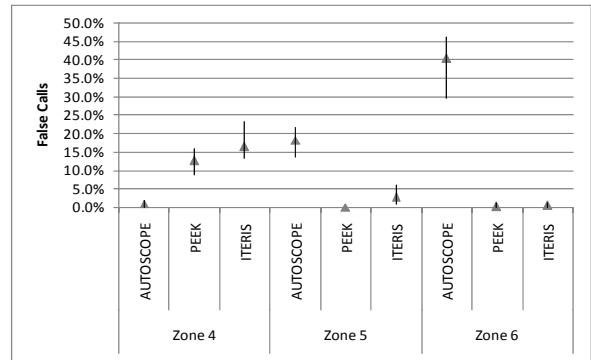
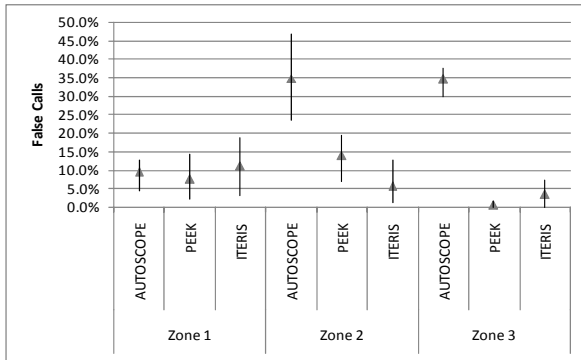

Missed Calls

Stop Bar Zones

Advance Zones

Zone	Day	Stop Bar Zones			Advance Zones				
		AUTOSCOPE	PEEK	ITERIS	AUTOSCOPE	PEEK	ITERIS		
ZONE 1	DAY 1	0.0%	0.0%	0.0%	ZONE 4	DAY 1	0.0%	2.5%	0.0%
	DAY 2	0.0%	0.0%	0.0%		DAY 2	0.0%	1.3%	0.0%
	DAY 3	0.0%	0.0%	0.0%		DAY 3	0.0%	0.0%	0.0%
	DAY 4	0.0%	0.0%	0.0%		DAY 4	0.0%	0.0%	0.0%
	DAY 5	0.0%	0.0%	0.0%		DAY 5	0.0%	0.0%	0.0%
ZONE 2	DAY 1	0.0%	0.0%	0.0%	ZONE 5	DAY 1	0.0%	7.5%	0.0%
	DAY 2	0.0%	0.0%	0.0%		DAY 2	0.0%	6.7%	0.7%
	DAY 3	0.0%	0.0%	0.0%		DAY 3	0.0%	0.9%	0.0%
	DAY 4	0.0%	0.0%	0.0%		DAY 4	0.7%	1.4%	0.0%
	DAY 5	0.0%	0.0%	0.0%		DAY 5	0.0%	0.0%	0.0%
ZONE 3	DAY 1	0.0%	15.9%	0.0%	ZONE 6	DAY 1	0.0%	2.3%	0.0%
	DAY 2	0.0%	20.7%	0.0%		DAY 2	0.0%	4.1%	0.8%
	DAY 3	0.0%	16.7%	0.0%		DAY 3	0.0%	0.0%	0.0%
	DAY 4	0.0%	21.1%	0.0%		DAY 4	0.8%	0.0%	0.0%
	DAY 5	0.0%	19.5%	0.0%		DAY 5	0.0%	1.4%	0.0%

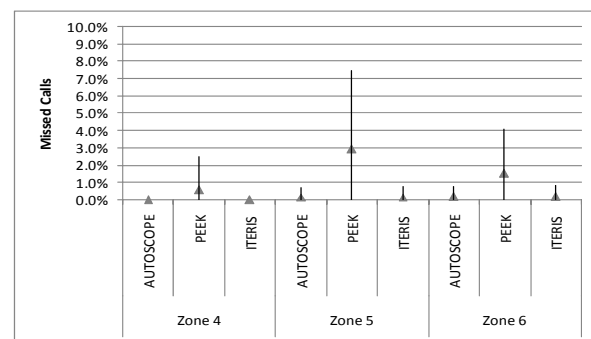
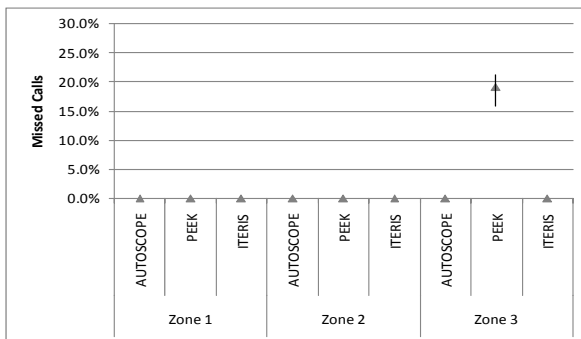

Stuck-on Calls

Stop Bar Zones

Advance Zones

Stop Bar Zones					Advance Zones				
		AUTOSCOPE	PEEK	ITERIS			AUTOSCOPE	PEEK	ITERIS
ZONE 1	DAY 1	0.0%	0.0%	0.0%	ZONE 4	DAY 1	0.0%	0.0%	0.0%
	DAY 2	0.0%	0.0%	0.0%		DAY 2	0.0%	0.0%	0.0%
	DAY 3	0.0%	0.0%	0.0%		DAY 3	0.0%	0.0%	0.0%
	DAY 4	0.0%	0.0%	0.0%		DAY 4	0.0%	0.0%	0.0%
	DAY 5	0.0%	0.0%	0.0%		DAY 5	0.0%	0.0%	0.0%
ZONE 2	DAY 1	1.0%	0.0%	0.0%	ZONE 5	DAY 1	0.0%	0.0%	0.0%
	DAY 2	0.0%	0.0%	0.0%		DAY 2	0.0%	0.0%	0.0%
	DAY 3	0.8%	0.0%	6.6%		DAY 3	0.0%	0.0%	0.0%
	DAY 4	0.0%	0.0%	6.1%		DAY 4	0.0%	0.0%	0.0%
	DAY 5	0.0%	0.0%	13.3%		DAY 5	0.0%	0.0%	0.0%
ZONE 3	DAY 1	0.0%	0.0%	0.0%	ZONE 6	DAY 1	0.7%	0.0%	0.0%
	DAY 2	0.0%	0.0%	0.0%		DAY 2	0.5%	0.0%	0.0%
	DAY 3	0.8%	0.0%	0.0%		DAY 3	0.0%	0.0%	0.0%
	DAY 4	0.0%	0.0%	3.4%		DAY 4	0.0%	0.0%	0.0%
	DAY 5	0.0%	0.0%	0.8%		DAY 5	0.0%	0.0%	0.0%

